

TE 96

MICROPROCESSOR-BASED DIGITAL ELECTRONIC TIMER



OSAKA

OPERATING INSTRUCTIONS Vr. 01 (ENG) - cod.: ISTR 06086

OSAKA

internet : <http://www.osakaproducts.com>
e-mail: support@osakaproducts.com

PREVIOUS STATEMENT:

In this manual are contained all the necessary information for a correct installation and the instructions for the use and the maintenance of the product; we recommend, therefore, to read carefully the following instructions.

The maximum care has been used in the realisation of this document, anyway OSAKA does not assume any responsibility deriving from the use of itself.

The same consideration has to be done for each person or Company involved in the creation of this manual.

The herewith issue is an exclusive property of OSAKA which forbids any reproduction and divulgation, although partial, if not expressly authorised.

OSAKA reserves the right to execute aesthetically and functional modifications, at any moment and without any notice.

INDEX

1	INSTRUMENT DESCRIPTION
1.1	GENERAL DESCRIPTION
1.2	FRONT PANEL DESCRIPTION
2	PROGRAMMING
2.1	SET POINT PROGRAMMING
2.2	PARAMETERS PROGRAMMING
2.3	PARAMETERS LOCK
3	INSTALLATION AND USE ADVICES
3.1	USE ALLOWED
3.2	MECHANICAL MOUNTING
3.3	ELECTRICAL CONNECTIONS
3.4	ELECTRICAL CONNECTION DRAWING
4	OPERATING MODE
4.1	COMMANDS OPERATING MODE
4.2	DISPLAY OPERATING MODE
4.3	OUT 1 OPERATING MODE
4.4	OUT 2 OPERATING MODE
4.5	CNT EN INPUT OPERATING MODE
5	PROGRAMMABLE PARAMETERS
5.1	PARAMETERS TABLE
5.2	PARAMETERS DESCRIPTION
6	TROUBLES, MAINTENANCE, WARRANTY
6.1	CLEANING
6.2	WARRANTY AND REPAIRS
7	TECHNICAL DATA
7.1	ELECTRICAL DATA
7.2	MECHANICAL DATA
7.3	MECHANICAL DIMENSIONS, PANEL CUT OUT AND FIXING DEVICE
7.4	FUNCTIONAL DATA
7.5	INSTRUMENT CODE

1 - INSTRUMENT DESCRIPTION

1.1 - GENERAL DESCRIPTION

TE 96 is a programmable microprocessor based timer with 1or 2 outputs.

The instrument offers the possibility to program: up to 3 set points time, 5 operating modes for the output OUT1, 4 operating modes for the output OUT2, 4 time scales (from 9999 hrs. maximum to 0.1 sec. minimum), 4 functioning modes of counting enable and 2 counting modes (UP or DOWN).

The instrument can be connected to an external back up battery (9 V) which permits the counting also without power supply.

The counting state is visualised on 4 digits display while the outputs state is signalised by a led.

The instrument can have 2 outputs (relay or to drive solid state relays) and 2 digital inputs for count enable (CNT EN) and reset (RES) which can be for free voltage contacts or voltage signals (the same voltage supply value).

The programming of the instrument is possible by means of the 3 keys placed on the front while the counting is possible using the frontal key START/STOP or using the back inputs CNT EN and RES.

1.2 - FRONT PANEL DESCRIPTION

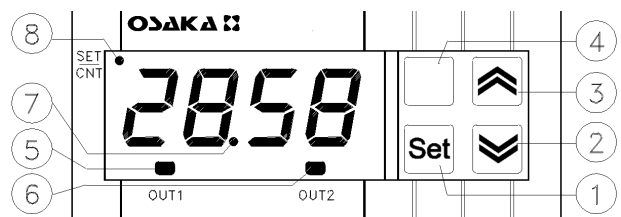

1 - Key Set : Used for the set point setting and to program the functioning parameters

2 - Key DOWN : Used to decrease the values or to select parameters

3 - Key UP : Used to increase the values or to select parameters

- 4 - **Key START/STOP** : Used to Start, Stop or reset the count
- 5 - **Led OUT 1** : It indicates when the output OUT1 is on or off.
- 6 - **Led OUT 2** : It indicates when the output OUT2 is on or off.
- 7 - **Led separator** : It indicates the separation between hours and minutes, minutes and seconds or seconds and cents.
- 8 - **Led SET/CNT** : Signalize the set point or the parameters programming mode (flashing fast), the count on (flashing each second), the count stopped (on) or reset mode (off).

2 - PROGRAMMING

2.1 – SET POINTS PROGRAMMING

The instrument permits to program up to 3 time sets: "t1", "t2", "t3".

To program this times do proceed as follows :

Pushing key Set and keeping it pushed for 1 sec. approx., the display will visualize "t1" and led SET/CNT will blink rapidly.

Releasing the key, on the display will be visualized the programmed Set Point "t1".

To modify it, work on keys UP, to increase the value or on key DOWN, to decrease it.

If the programmed functioning mode require the set "t2" (F1 = 3, 4 or 5), for programming this pressing key Set again and the display will show "t2".

Releasing the key, on the display will be visualized the programmed Set Point "t2" and will be possible to modify it by the key UP or DOWN.

If the programmed functioning mode require the set "t3" (F2 = 3 or 4), for programming this pressing key Set again and the display will show "t3".

Releasing the key, on the display will be visualized the programmed Set Point "t3" and will be possible to modify it by the key UP or DOWN.

The outgoing from the set points programming it's automatically obtainable not working on any key for 5 sec. approx. or pressing only one time the key Start/Stop, thus the counting value will again be displayed.

The programming of the set times is always possible, both with counting on or off.

2.2 – PARAMETERS PROGRAMMING

To have access at the functioning parameters, it's necessary to push key Set and keep it pushed for 5 sec. approx.

After 4 sec. will appear the label of the first parameter ("F1").

Now it possible to release key Set and it will appear the value programmed for parameter "F1".

To modify this value work on keys UP or DOWN.

Once the desired value has been programmed, pushing again key Set the display will show the label of the successive parameter.

Releasing then key Set, it will appear the value programmed for that parameter which can be modified working on keys UP and DOWN.

Pushing and releasing key Set it's possible to visualize all the parameters labels (when key is pushed) and the relative programming (when key is released) one after the other.

The outgoing from the parameters programming it's obtainable not working on any key for 20 sec. approx. or pressing only one time the key Start/Stop, thus the counting value will again be displayed.

P.A.: During the counting is not possible to enter in the parameters programming mode.

2.3 – PARAMETERS LOCK

It's possible to lock the access at the programming parameters with the following procedure :

Switch off the instrument, push key Set and keep it pushed while the instrument is switched on again.

After approx. 5 sec. on the display will appear "uL" (unlock) which indicates that the parameters are accessible.

Keeping pushed key P and pushing key DOWN it will appear "Lo" (lock) which indicates that the parameters are not accessible.

Release key Set to exit from this modality.

The display will go back to the normal functioning, the parameters will not be accessible anymore and it will only be possible to modify the Set Point.

To have again access at the parameters, repeat the same procedure pushing key Set and selecting "uL" ; finally go out from the parameters lock modality.

3 - INSTALLATION AND USE ADVICES



3.1 – USE ALLOWED

The instrument has been projected as measure and control device, built according to EN61010-1 for the altitudes operation until 2000 ms.

The use of the instrument for applications not expressly allowed by the above mentioned rule has

to foreseen proper protection devices.

The instrument CAN'T be used in environments with dangerous atmosphere (flammable or explosive) without a proper protection.

It has to be reminded that the user has to take care that the electromagnetic rules are being respected also after the instrument installing, eventually using proper filters.

Whenever a failure or a bad functioning of the instrument may cause dangerous situations or damage to people, things or animals it has to be reminded that the plant has to be equipped with additional electromechanical devices in order to grant the safety.

3.2 – MECHANICAL MOUNTING

The instrument, in case 33 x 75 mm, is designed for flush-in panel mounting.

Make a hole 29 x 71 mm and insert the instrument, fixing it with the provided special bracket.

We recommend to mount the gasket to obtain the front protection degree as declared. Do avoid to place the instrument in ambient with very high humidity or dirt that may create condensation or introduction into the instrument of conductive substances.

Ensure the adequate ventilation to the instrument and avoid the installation within boxes where are placed devices which may overheat or have as a consequence the instrument's functioning at higher temperature than allowed and declared.

Connect the instrument as far as possible from source of electromagnetic disturbances so as motors, power relays, relays, electrovalves, etc.

3.3 – ELECTRICAL CONNECTIONS

Carry out the electrical wiring connecting only one wire for each terminal, according to the following diagram, checking that the power supply is the same as indicated on the instrument and the loads current is not higher than the maximum current admitted.

The instrument, being a built in equipment with permanent connection into a cabinet, is not equipped neither with switches nor with internal devices protecting from overcurrent : the installation shall employ a two-phase circuit-breaker, placed as near as possible to the instrument, located in a position easily reachable by the user and marked as instrument disconnecting device.

It's recommended, furthermore, to properly protect all the electric circuits connected to the instrument, with devices (ex. fuses) proportionate to the circulating currents.

It's strongly recommended to use cables with proper insulation, according to the working voltages and temperatures.

Furthermore, the input cable of the probe has to be kept separate from line voltage wiring. If the input cable of the probe is screened, it has to be connected on the ground with only one side.

When you choose the "b" parameter with option 2 (timer goes on operating in case of power failure) is necessary to connect the external battery.

With the purpose to prolong its duration it recommends him to disconnect the battery when it is not necessary to the operation.

Finally, it is advisable to check that the parameters are those desired before connecting the outputs to the actuators in order to avoid plant anomalies which may cause injuries to people, things or animals.

OSAKA and its legal representatives are not responsible for any eventual damages to people, things or animals deriving from the instrument violation, not proper or wrong use or in any case not in accordance with the instrument features.

3.4 - ELECTRICAL CONNECTION DRAWING

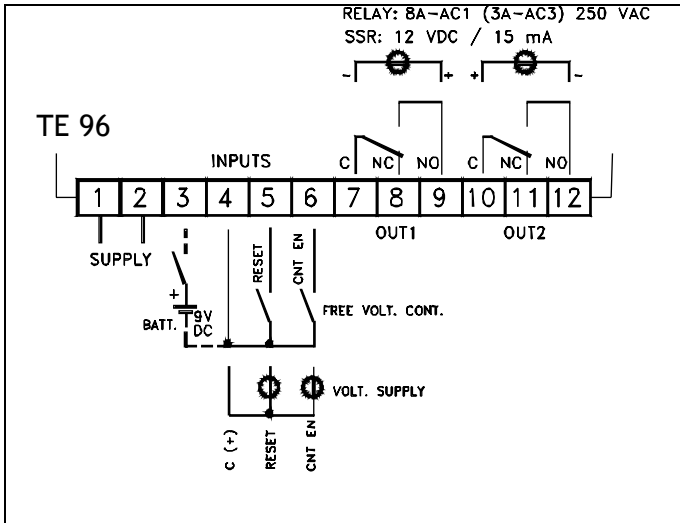

4 - OPERATING MODE

4.1 - FUNCTIONING OF THE COUNTING COMMANDS

The counting can be enabled and disabled through the frontal key Start/Stop, or through the remote inputs CNT EN and RES.

The operating mode of the key Start/Stop is defined by the parameter "t", the operating mode of the input CNT EN is defined by the parameter "E" while the input RES always works as reset, i.e. it stops and resets the counting when it is activated and moreover it has priority on the other commands (when it is activated it doesn't allow the starting of the counting).

When the instrument is predisposed for the continuation of the counting also without power supply, during the counting under conditions of lack of supply the only active command is the RESET one, which can be given only from the frontal key Start/Stop.

When the instrument is supplied through the battery it is not therefore possible to make the counting start again once stopped.

4.2 - FUNCTIONING OF THE DISPLAY

The led SET/CNT is used to indicate the access into the programming (flashing fast), the counting in action (flashing each second), the counting interrupted before the term (lighted fixed) or the counting finished and the state of reset (off).

After the reset, the display visualizes 0000 if the counting mode is programmed as UP (par. "C" = 1) or it visualizes the programmed set value if the counting mode is programmed as DOWN (par. "C" = 2).

During the counting, the display visualizes the value of time that spends in UP or in DOWN mode.

If the back-up mode has been programmed to continue the counting in action without power supply, the display remains lighted but with an inferior brightness (with the purpose to limit as much as possible the absorption from the battery).

4.3 - OUT1 OPERATING MODE

The instrument can be programmed by the parameter "F1" to operate in any of the following 5 modes:

F1 = 1 - DELAYED :

On receiving the START signal, the instrument starts counting time. When the set time value "t1" has been reached, the instrument enables the output OUT1.

The output is disabled by the RESET signal.

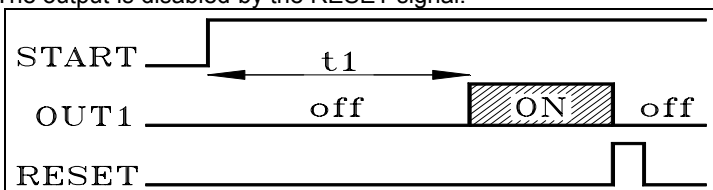

F1 = 2 - FEEDTHROUGH :

On receiving the START signal, the instrument enables the output OUT1.

The output is disabled when the set time value "t1" has been reached.

The output will be enabled again after the transmission of a RESET signal and a subsequent START signal.

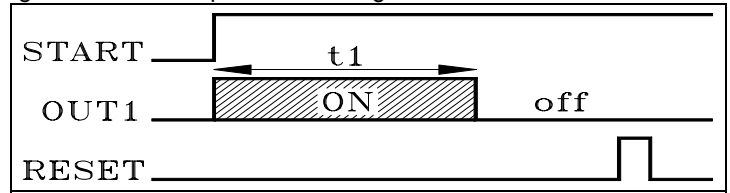

F1 = 3 - ASYMMETRICAL OSCILLATOR START ON:

This operating mode allows the user to enter two SET times "t1" and "t2", and therefore also involves the "S2" parameter.

On receiving the START signal, the output OUT1 is immediately enabled and remains enabled for the time period t1.

Then the output is disabled and remains disabled for the time period t2.

This procedure goes on until a RESET signal is transmitted.

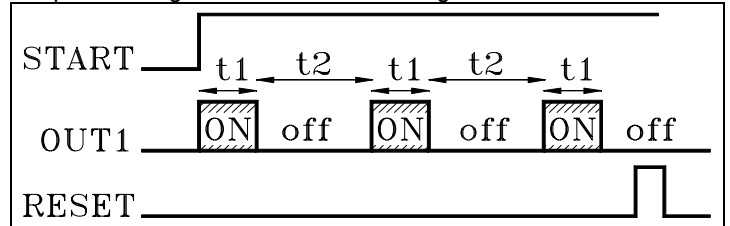

F1 = 4 - ASYMMETRICAL OSCILLATOR START OFF:

This operating mode allows the user to enter two SET times "t1" and "t2", and therefore also involves the "S2" parameter.

On receiving the START signal, the output remains disabled until the set time period "t1" has expired.

Then the output is enabled.

The output is disabled again when the set time period "t2" has expired. This procedure goes on until a RESET signal is transmitted.

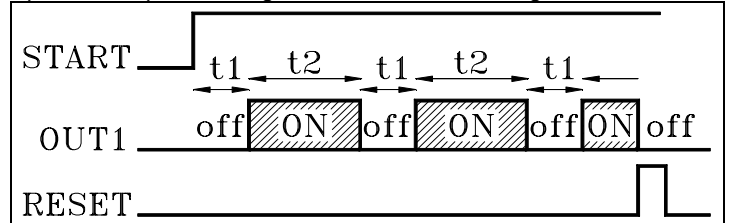

F1 = 5 - ONE CYCLE ASYMMETRICAL OSCILLATOR START OFF:

The operation results similar to the "F1"=4 with the only difference that only one cycle of OFF/ON is performed.

To the start signal the output OUT1 remains disabled for the time "t1".

When the time "t1" is expire the output will be on for the time "t2".

The cycle will be enabled again after the transmission of a RESET signal and a subsequent START signal.

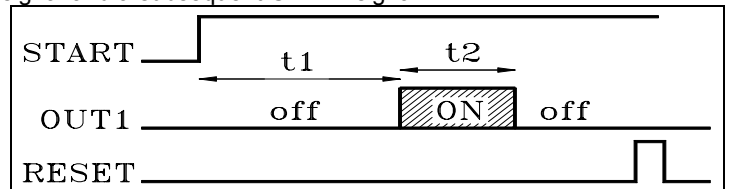

4.4 - OUT2 OPERATING MODE

The instrument can be programmed by the parameter "F2" to operate in any of the following 4 modes:

F2 = 1 - Output OUT2 operating like OUT1

The output OUT2 exactly operates like the output OUT1 so that to be able to have two output contacts.

F2 = 2 - Output OUT2 operating as instant contact

The output OUT2 is activated during the counting phase and remains activated to the reset command.

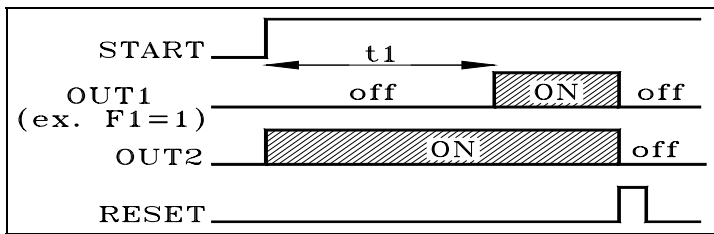

Received the start signal the instrument begins the counting and exactly operating on the output OUT 2 in the same way with which it operates the function F1 on the output OUT1.

If F1 = 1, 4 or 5 the output OUT 2 operate with the function of delay with the time ["t1" - "t3"] while if F1 = 2 or 3 the output OUT 2 operate with the feedthrough_function always with the time ["t1" - "t3"].

In the programming mode of the time "t3" the display shows "t3 d" to indicate that the time t3 is dependent.

F2 = 3 - Same function of OUT1 (time t1) with time t3 absolute:

The choice of this mode of operation enable the set "t3" that it has the same range time "S1" and cannot be higher of "t1."

Received the start signal the instrument begins the counting and exactly operating on the output OUT 2 in the same way with which it operates the function F1 on the output OUT1.

If F1 = 1, 4 or 5 the output OUT 2 operate with the function of delay with the time "t3" while if F1 = 2 or 3 the output OUT 2 operate with the feedthrough_function always with the time "t3."

In the programming mode of the time "t3" the display shows "t3 i" to indicate that the time t3 is independent.

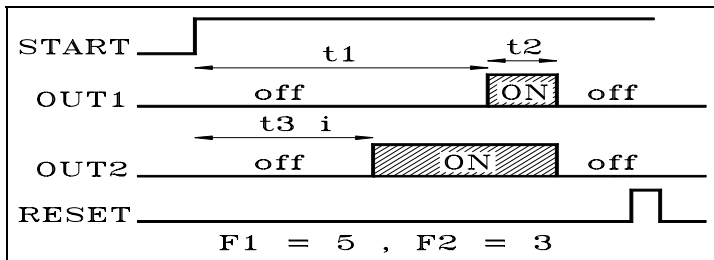
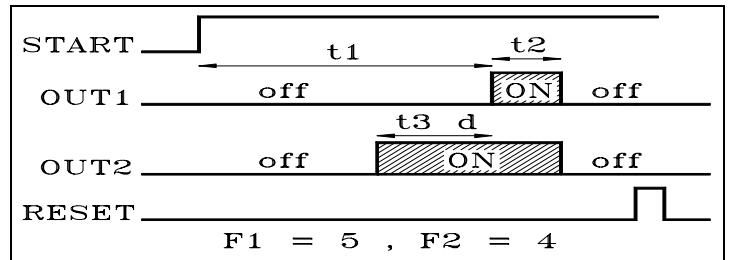
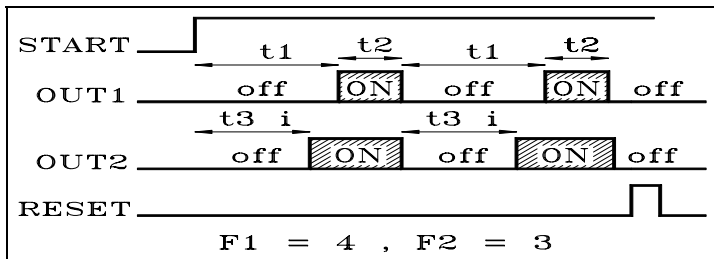
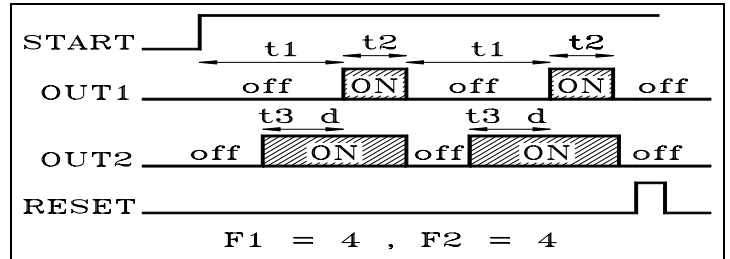
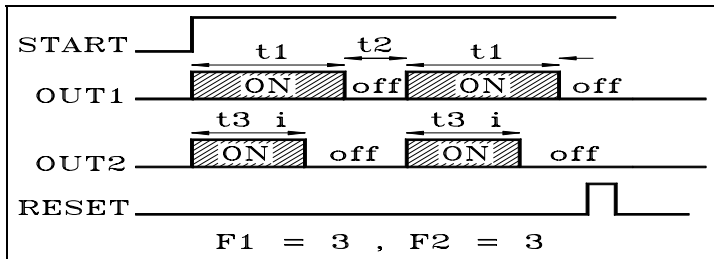
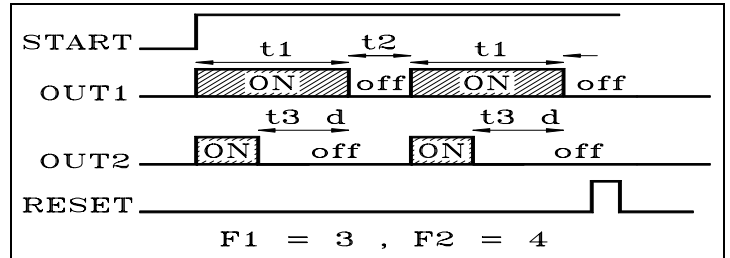
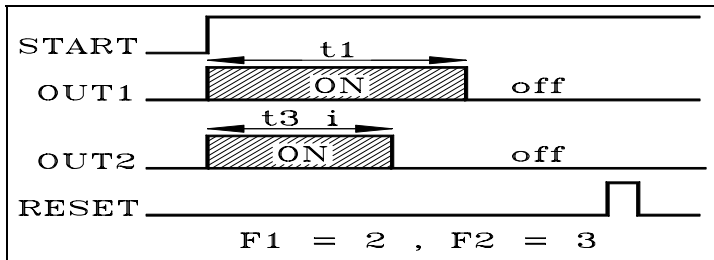
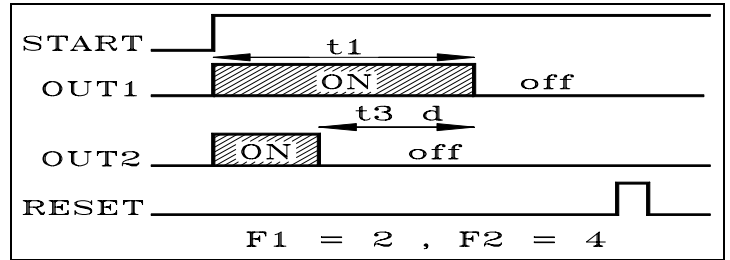
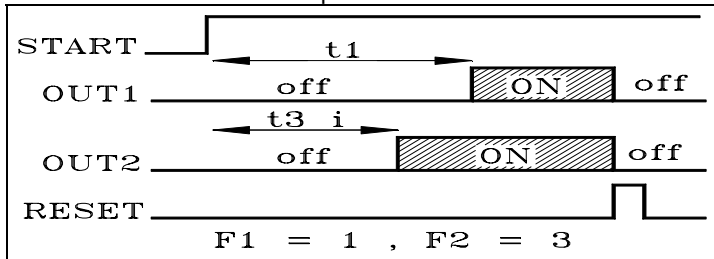
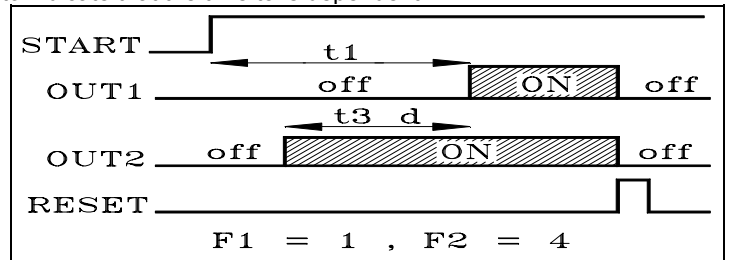

If "F2" = 0 the output OUT 2 is always disabled.

4.5 - CNT EN INPUT OPERATING MODE

The start signal can be given by the frontal key Start/Stop programmed as START/STOP function ("t"=1 or 2), which normally has bistable functioning, or by the CNT EN input count enable.

As regards the CNT EN input, which enables time counting, the instrument can be programmed to operate in any of the following 4 modes:

E = 1 - BISTABLE START/STOP:

After resetting the timer using the RESET input, close the CNT EN contact to start the timer. Now release the contact.

When the contact is closed again, the timer stops on the current counting value.

F2 = 4 - Same function of OUT1 (time t1) with time t3 relative to t1 (in advance): The choice of this mode of operation enable the set "t3" that it has the same range time "S1" and cannot be higher of "t1."

The timer starts again following another impulse to the CNT EN input port.

This procedure goes on until a RESET signal is transmitted or the set time period has expired.

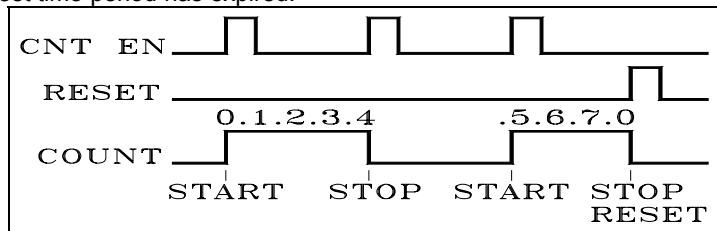

E = 2 - BISTABLE RESET-START/STOP:

This operating mode is very similar to that of the front START/STOP key and depends also from "t" parameter which has 2 possible functioning modes:

E = 2, t = 1 - RESET-START/STOP:

The first impulse on CNT EN input reset and start the timer, at the second impulse, if it is given before the end of the time, the timer stops (if the output was activated now will be disabled), otherwise, if it is given after the end of the time, the second pulse activates a new counting cycle.

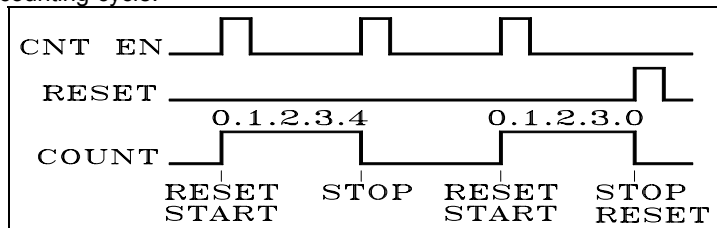

E = 2, t = 2 - RESET/START/STOP:

At the first pulse on CNT EN input the timer is resetted, at the second the counting starts, at the third pulse the counting is stopping, and so on.

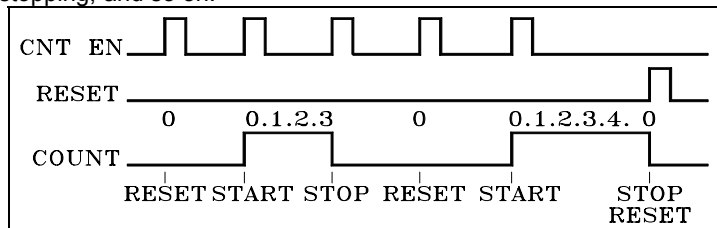

E = 3 - MONOSTABLE START/STOP:

After being reset by means of the RESET input, the timer starts when the CNT EN contact is closed and stops when the contact is opened.

At this point, if the contact is closed again, the timer will re-start from the current value, and so on until a RESET signal is transmitted or the set time period has expired.

In this functioning mode the Start/Stop frontal key works only as reset.

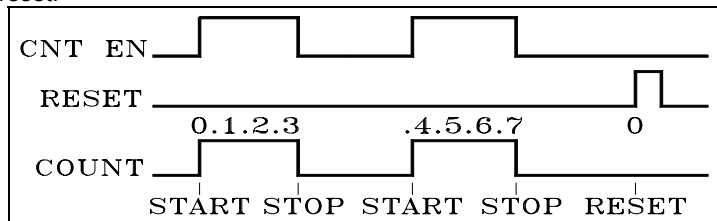

E = 4 - MONOSTABLE RESET-START/STOP:

By closing the CNT EN input and keeping it closed, the timer is resetted and starts the counting, at the opening of the CNT EN input the counting is stopped.

This operating mode is recommended when the user wants to control the timer using voltage signals. In fact, with an appropriate interface (eg. an external relay) the timer is reset and starts counting when voltage is supplied, and stops when voltage is cut off (just like a conventional timer).

In this functioning mode the Start/Stop frontal key works only as reset.

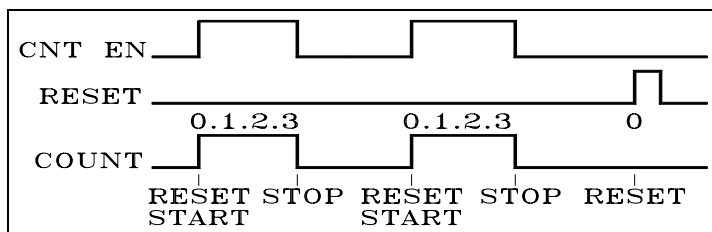

5 - PROGRAMMABLE PARAMETERS

5.1 - PARAMETERS TABLE

Par.	Description	Range	Def.	Notes
1	F1 OUT 1 operating mode	1 - 2 - 3 - 4 - 5	1	
2	F2 OUT 2 Operating mode	0 - 1 - 2 - 3 - 4	0	
3	S1 Time Range "t1"	1 - 2 - 3 - 4	1	
4	S2 Time Range "t2"	1 - 2 - 3 - 4	1	
5	H1 Maximum set time "t1"	00 _ _ ... 99 _ _	99 _ _	
6	H2 Maximum set time "t2"	00 _ _ ... 99 _ _	99 _ _	
7	C Counting mode	1 - 2	1	
8	b Back-up mode	1 - 2 - 3	1	
9	E CNT EN input operating mode	1 - 2 - 3 - 4	1	
10	t Start/Stop key operating mode	0 - 1 - 2 - 3	1	

5.2 - PARAMETERS DESCRIPTION

F 1 - OUT 1 OPERATING MODE: Permits the user to select the operating mode of the output OUT 1 as regards counting.

The 5 mode are:

- 1 = Delayed
- 2 = Feedthrough
- 3 = Asymmetrical Oscillator Start Off
- 4 = Asymmetrical Oscillator Start On
- 5 = One cycle Asymmetrical Oscillator Start Off

F 2 - OUT 2 OPERATING MODE: Permits the user to select the operating mode of the output OUT 2 as regards counting.

The 5 mode are:

- 0 = Output disable
- 1 = Operating like OUT1
- 2 = On during counting
- 3 = Same function of OUT1 with time t3 absolute
- 4 = Same function of OUT1 with time t3 dependent from time t1

S1 - TIME RANGE t1 (and t3) : This parameter allows the user to select the full range of the time t1 (and t3 if activate) according to the following options:

- 1 = hrs (9999)
- 2 = hrs - min. (99 hrs 59 min.)
- 3 = min. - sec. (99 min. 59 sec.)
- 4 = sec. - cents (99 sec. 99 cents).

S2 - TIME RANGE t2: This parameter only involves the operating modes "F1"= 3 and 4, and is used to select the full range of the t2 time period. The options are the same as for the "S1" parameter.

H1 - HIGH SET POINT TIME t1 : This parameter allows the user to program the 2 most significative figures of the Higher value programmable as Set Point "t1"

H2 - HIGH SET POINT TIME t2: Similar to "H1" but referred to the set "t2".

C - COUNTING MODE. Permits the user to choose the UP or DOWN mode, ie. whether the display must show the time which has passed or the remaining time. The options are:

- 1 = UP mode
- 2 = DOWN mode

b - BACK-UP MODE. This parameter determines the instrument reaction in the case of power failure. The options are:

- 1 = Timer stops and memorized the counting current value
- 2 = Timer goes on counting (only with external battery connected)
- 3 = Timer reset the counting

When option 1 has been chosen, the instrument goes off and the counting current value is saved. When the power supply is restored, the timer can start working from the saved value.

When option 2 has been chosen, in the case of power failure the display and the output will go off, but the timer will continue to count. Note that the mode 2 is enabled only if the external battery is present (see electrical connections).

Under these conditions of operation the display results turned on but with an inferior brightness to the normal mode

We recommend to disable the battery when it is not necessary.

In case 3 finally, at the missing of power supply, the instrument stops the counting and does not memorize the reached value, so that at the returning of power supply the instrument will be in the reset conditions.

E - CNT EN INPUT OPERATING MODE. Allows the user to select the operating mode of the Count Enable (CNT EN) external input.

The options are:

- 1 = Bistable Start/Stop
- 2 = Bistable Reset-Start/Stop
- 3 = Monostable Start/Stop
- 4 = Monostable Reset-Start/Stop

t - START/STOP KEY OPERATING MODE: This parameter permits to decide the operating mode of the frontal Start/Stop key and the possibilities are:

- 0 = Key disable
- 1 = RESET-START/STOP
- 2 = RESET/START/STOP
- 3 = RESETOnly

6 - PROBLEMS, MAINTENANCE AND WARRANTY

6.1 – CLEANING

It's recommended to clean the instrument only with a cloth wetted with water or with a detergent neither abrasive nor containing solvents.

6.2 – WARRANTY AND REPAIRS

The instrument is under warranty against construction vices or defected material, noticed within 12 months from delivery date. The warranty is limited to the repairs or to the substitution of the instrument. The eventual opening of the housing, the violation of the instrument or the wrong use and installation of the product means the automatic decay of the warranty.

In case of defected instrument, noticed in warranty period or out of warranty, do contact our sales department to obtain the shipment authorisation.

The defected product must be shipped to OSAKA with the detailed description of the failures found and without any fees or charge for OSAKA, save different agreements.

7 - TECHNICAL DATA

7.1 – ELECTRICAL DATA

Power supply: 12 VDC/VAC, 24, 115, 230 VAC +/- 10%

Frequency AC: 50/60 Hz

Power consumption: 2 VA approx.

Input/s: 2 digital inputs for Count Enable (CNT EN) and Reset (RES) for voltage-free contacts or voltage signals (the same voltage supply value).

Output/s: Up to 2 outputs. Relay SPDT (8 A-AC1, 3 A-AC3 / 250 VAC); or in tension to drive SSR (12VDC/15 mA).

Electrical life for relay outputs: 100000 operat.

Battery for counting without supply: 9 V (form E) external not rechargeable battery.

Consumption with battery supply: 9 mA approx.

Voltage inputs absorption: 1 mA Max.

Installation category: II

Protection class against electric shock: Class II for Front panel

Insulation: Reinforced insulation between the low voltage section (supply and relay outputs) and the front panel; Reinforced insulation between the low voltage section (supply and relay outputs) and the extra low voltage section (inputs, SSR outputs); Reinforced

insulation between the extra low voltage section (SSR outputs) and voltage inputs.

7.2 – MECHANICAL DATA

Housing: Self-extinguishing plastic, UL 94 V0

Dimensions: 33 x 75 mm, depth 64 mm

Weight: 175 g approx.

Mounting: Flush in panel in 29 x 71 mm hole

Connections: 2,5 mm² screw terminals block

Degree of front panel protection: IP 65 mounted in panel with gasket

Pollution situation: 2

Operating temperature: 0 ... 55 °C

Operating humidity: 30 ... 95 RH% without condensation

Storage temperature: -10 ... +60 °C

7.3 – MECHANICAL DIMENSIONS, PANEL CUT OUT AND FIXING DEVICE [mm]

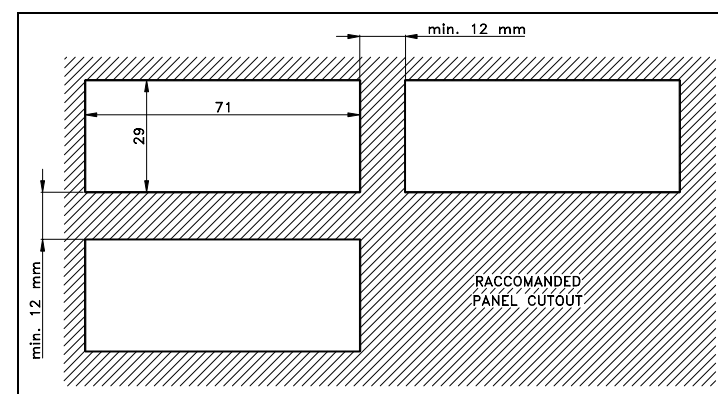
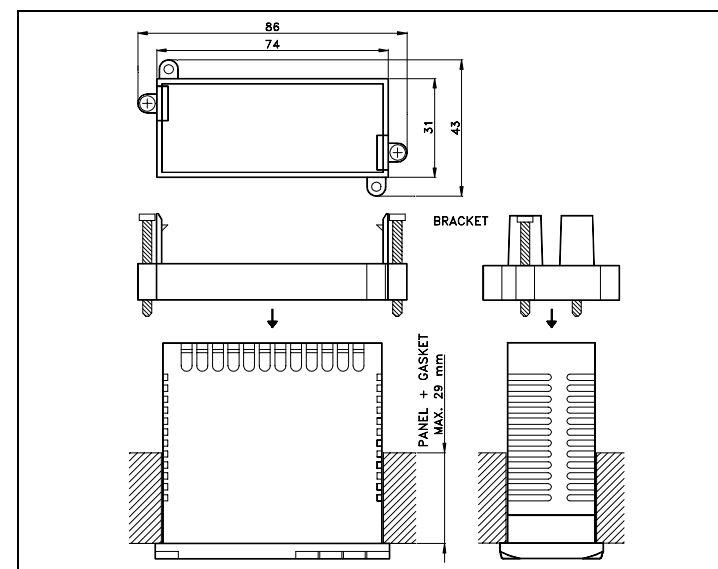
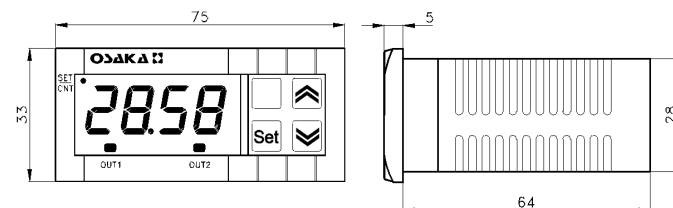

7.4 – FUNCTIONAL DATA

Outputs operating mode: 5 modes for OUT 1: Delayed, Feedthrough, asymmetric times oscillator with start on or start off and One cycle Asymmetrical Oscillator Start Off.

4 modes for OUT 2: like OUT1, ON during count, like OUT1 with time t3 absolute or relative in advance.

Measurement range: 4 times scales: 9999 hrs., 99 hrs. 59 min., 59 min. 59 sec., 99 sec. 99 cents.

Display resolution: according to the scale used: hrs., min., sec., cents

Overall accuracy: +/- 0,1 % fs

Counting autonomy in case of power failure: depending on battery capacity (ex. with a 400 mAh full charge battery the autonomy is 44 hrs. approx)

Inputs delay: 15 m sec. Max.

Display: 4 Digit Red h 12 mm

Compliance: ECC directive EMC 89/336 (EN 61326), ECC directive LV 73/23 and 93/68 (EN 61010-1)

7.5 – INSTRUMENT CODE

TE 96 a b c d ee

a : POWER SUPPLY

F = 12 VAC/VDC

A = 24 VAC

C = 115 VAC

D = 230 VAC

b : INPUTS

C = Free voltage contacts

V = Voltage signals (the same voltage supply value).

c : OUTPUT OUT1

R = Relay

O = 12 VDC for SSR

d : OUTPUT OUT2

R = Relay

O = 12 VDC for SSR

- = None

ee = SPECIAL CODES