



MICROPROCESSOR-BASED DIGITAL ELECTRONIC CONTROLLER OK 81



OPERATING INSTRUCTIONS Vr. 02 (ENG) - cod.: ISTR 06265

OSAKA

internet : <http://www.osakaproducts.com>

e-mail: support@osakaproducts.com

FOREWORD:

This manual contains the information necessary for the product to be installed correctly and also instructions for its maintenance and use; we therefore recommend that the utmost attention is paid to the following instructions.

Though this manual has been issued with the greatest care, OSAKA will not take any responsibility deriving from its use.

The same applies to each person or Company involved in the issuing of this manual.

This document is the exclusive property of OSAKA which forbids any reproduction and divulgation, even in part, of the document, unless expressly authorized.

OSAKA reserves the right to make any formal or functional changes at any moment and without any notice.

INDEX

- 1 **INSTRUMENT DESCRIPTION**
 - 1.1 GENERAL DESCRIPTION
 - 1.2 FRONT PANEL DESCRIPTION
- 2 **PROGRAMMING**
 - 2.1 FAST PROGRAMMING OF SET POINT
 - 2.2 SELECTION OF CONTROL STATE AND PARAMETER PROGRAMMING
 - 2.3 PARAMETER PROGRAMMING LEVELS
 - 2.4 CONTROL STATES
 - 2.5 ACTIVE SET POINT SELECTION
- 3 **INFORMATION ON INSTALLATION AND USE**
 - 3.1 PERMITTED USE
 - 3.2 MECHANICAL MOUNTING
 - 3.3 ELECTRICAL CONNECTIONS
 - 3.4 ELECTRICAL WIRING DIAGRAM
- 4 **FUNCTIONS**
 - 4.1 MEASURING AND VISUALIZATION
 - 4.2 OUTPUTS CONFIGURATION
 - 4.3 ON/OFF CONTROL
 - 4.4 NEUTRAL ZONE ON/OFF CONTROL
 - 4.5 SINGLE ACTION PID CONTROL
 - 4.6 DOUBLE ACTION PID CONTROL
 - 4.7 AUTO-TUNING AND SELF-TUNING FUNCTIONS
 - 4.8 REACHING OF SET POINT AT CONTROLLED SPEED AND AUTOMATIC COMMUTATION BETWEEN TWO SET POINTS
 - 4.9 SOFT-START FUNCTION
 - 4.10 ALARM FUNCTIONS
 - 4.10.1 ALARM OUTPUT CONFIGURATION
 - 4.10.2 ALARM HYSTERESIS
 - 4.11 HEATER BREAK ALARM FUNCTION
 - 4.12 LOOP BREAK ALARM FUNCTION
 - 4.13 FUNCTION OF KEY "F"
 - 4.14 RS 485 SERIAL INTERFACE
 - 4.15 PARAMETERS CONFIGURATION BY KEYPC
- 5 **PROGRAMMABLE PARAMETERS**
 - 5.1 PARAMETERS TABLE
 - 5.2 PARAMETERS DESCRIPTION
- 6 **PROBLEMS, MAINTENANCE AND GUARANTEE**
 - 6.1 ERROR SIGNALLING
 - 6.2 CLEANING
 - 6.3 GUARANTEE AND REPAIRS
- 7 **TECHNICAL DATA**
 - 7.1 ELECTRICAL DATA
 - 7.2 MECHANICAL DATA
 - 7.3 MECHANICAL DIMENSIONS, PANEL CUT-OUT AND MOUNTING
 - 7.4 FUNCTIONAL DATA
 - 7.5 MEASUREMENT RANGE TABLE
 - 7.6 INSTRUMENT ORDERING CODE

1 - INSTRUMENT DESCRIPTION

1.1 - GENERAL DESCRIPTION

OK 81 is a "single loop" digital microprocessor-based controller, with ON/OFF, Neutral Zone ON/OFF, PID single action, PID dual action (direct and reverse) control and with **AUTO-TUNING FAST** function, **SELF-TUNING** function and automatic calculation of the **FUZZY OVERSHOOT CONTROL** parameter for PID control.

The PID control has a particular algorithm with **TWO DEGREES OF FREEDOM** that optimises the instrument's features independently in the event of process disturbance and Set Point variations.

Furthermore, the instrument allows for RS485 serial communication using MODBUS-RTU communication protocol and a transmission speed up to 38.400 baud.

The process value is visualized on 4 red displays, while the output status is indicated by 4 LED displays.

The instrument is equipped with a 3 LED programmable shift indexes.

The instrument provides for the storage of 4 Set Points and can have up to 4 outputs: relay type or can drive solid state relays type (SSR).

The input is programmable and accepts temperature probes (Thermocouples J,K,S; Thermo-resistances PT100, Thermistors PTC and NTC; Infrared sensors) and normalized analogue signals (0/4..20 mA, 0/1..5 V, 0/2..10 V, 0..50/60 mV, 12..60 mV).

The instrument can be equipped with an input for the current transformer, working as Heater Break Alarm function.

Other important available functions are: Loop-Break Alarm function, reaching of the Set Point at controlled speed, ramp and dwell function, Soft-Start function, PC configuration, parameters protection on different levels.

1.2 - FRONT PANEL DESCRIPTION

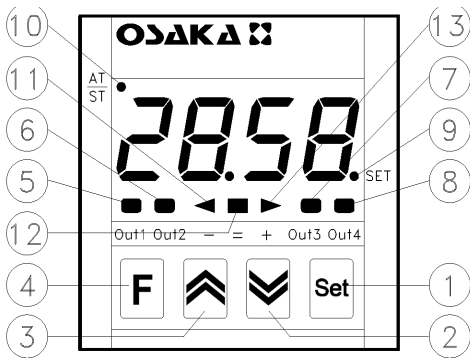

1 - Key Set : This is used to access the programming parameters and to confirm selection.

2 - Key DOWN : This is used to decrease the values to be set and to select the parameters. If the key is held down, the user returns to the previous programming level until he exits the programming mode. Outside the programming mode it permits visualisation of the current measured by the TAHB input.

3 - Key UP : This is used to increase the values to be set and to select the parameters. If the key is held down, the user returns to the previous programming level until he exits the programming mode. Outside the programming mode it permits visualisation of the output control power.

4 - Key F : This is a key with a function programmable by par. "USrb". It can be set to : Activate Auto-tuning and Self-tuning functions, swap the instrument to manual control, silence the alarm, change the active Set Point, deactivate control.

5 - Led OUT1 : indicates the state of output OUT1

6 - Led OUT2 : indicates the state of output OUT2

7 - Led OUT3 : indicates the state of output OUT3

8 - Led OUT4 : indicates the state of output OUT4

9 - Led SET : when flashing, it indicates access to the programming mode.

10 - Led AT/ST : indicates that the Self-tuning function is activated (light on) or that Auto-tuning (flashing) is in progress.

11 - Led - Shift index: indicates that the process value is lower than the one programmed on par. "AdE".

12 - Led = Shift index: indicates that the process value is within the range [SP+AdE ... SP-AdE]

13 - Led + Shift index: indicates that the process value is higher than the one set on par. "AdE".

2 - PROGRAMMING

2.1 - FAST PROGRAMMING OF THE SET POINT

This procedure permits rapid programming of the active Set Point and possibly the alarm thresholds (see par 2.3)

Push key "Set", then release it and the display will visualise "SPn" (where n is the number of the Set Point active at that moment) alternatively to the programmed value.

To modify the value, press "UP" key to increase it or the "DOWN" key to decrease it.

These keys change the value one digit at a time but if they are pressed for more than one second, the value increases or decreases rapidly and, after two seconds in the same condition, the changing speed increases in order to allow the desired value to be reached rapidly.

Once the desired value has been reached, by pushing key Set it is possible to exit by the fast programming mode or it is possible to visualise the alarm thresholds (see par. 2.3).

To exit the fast Set programming it is necessary to push key Set, after the visualisation of the last Set Point, or alternatively, if no key is pressed for approx. 15 seconds, the display will return to normal functioning automatically.

2.2 - SELECTION OF THE CONTROL STATE AND PARAMETER PROGRAMMING

By pushing key "Set" and holding it down for approx. 2 sec. it is possible to enter into the main selection menu.

Using the "UP" or DOWN" keys, it is then possible to roll over the selections:

"OPER"	to enter into the operating parameters menu
"ConF"	to enter into the configuration parameters menu
"OFF"	to swap the regulator into the OFF state
"rEG"	to swap the regulator into the automatic control state
"tunE"	to activate the Auto-tuning or Self-tuning function
"OPLO"	to swap the regulator to the manual control state and therefore to program the % control value using the "UP" and "DOWN" keys

Once the desired item has been selected, push key "Set" to confirm. Selecting "OPER" and "ConF" gives the possibility of accessing other menus containing additional parameters and more precisely :

"OPER" - Operating parameters Menu: this normally contains the Set Point parameters but it can contain all the desired parameters (see par. 2.3).

"ConF" - Configuration parameters Menu: this contains all the operating parameters and the functioning configuration parameters (alarm configuration, control, input, etc.)

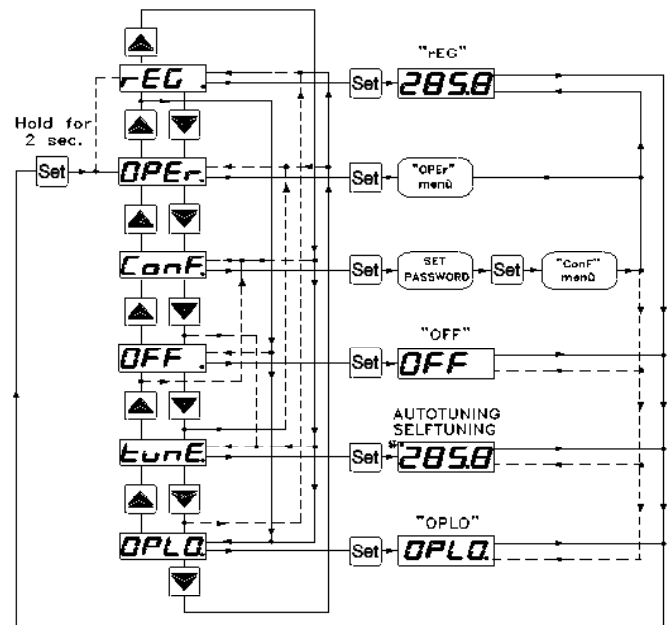

To enter the menu "OPER", select the option "OPER" and press the key "Set".

The display will now show the code identifying the first group of parameters ("1SP") and by pressing the "UP" and "DOWN" keys it will be possible to select the group of parameters to be modified.

Once the desired group of parameters has been selected, the code identifying the first parameter of the selected group will be visualised by pushing the "Set" key.

Again using the "UP" and "DOWN" keys, it is possible to select the desired parameter and, if the key "Set" is pressed, the display will alternatively show the parameter's code and its programming value, which can be modified by using the "UP" or "DOWN" keys.

Once the desired value has been programmed, push key "Set" once more: the new value will be memorised and the display will show only the code of the selected parameter.

By using the "UP" or "DOWN" keys, it is then possible to select a new parameter (if present) and modify it as described above.

To select another group of parameters, keep the "UP" or "DOWN" key pressed for approx. 2 sec., afterwards the display will return to visualise the code of the group of parameters.

Release the key and by using the "UP" and "DOWN" keys, it will be possible to select a new group (if present).

To exit the programming mode, no key should be pressed for approx. 20 seconds, or keep the "UP" or "DOWN" pressed until exit from the programming mode is obtained.

To enter the menu "ConF" a PASSWORD is required.

At this request, enter, using keys "UP" and "DOWN", the number reported on the last page of this manual and push key "Set".

If an incorrect password is entered, the instrument returns to the previous control state.

If the password is correct, the display will visualise the code identifying the first group of parameters ("1SP") and with keys "UP" and "DOWN" it will be possible to select the desired group of parameters

The programming and exit modes for the "ConF" menu are the same as those described for menu "OPER".

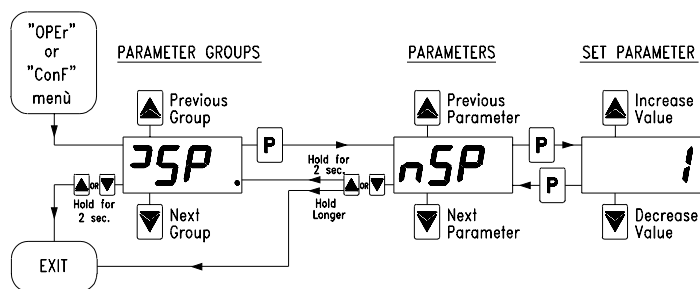

2.3 - PARAMETERS PROGRAMMING LEVELS

The menu "OPER" normally contains the parameters used to program the Set Point; however it is possible to make all desired parameters appear or disappear on this level, by following this procedure:

Enter the menu "ConF" and select the parameter to be made programmable or not programmable in the menu "OPER".

Once the parameter has been selected, if the LED SET is switched off, this means that the parameter is programmable only in the menu "ConF", if instead the LED is on, this means that the parameter is also programmable in the menu "OPER".

To modify the visibility of the parameter, push key "F": the LED SET will change its state indicating the parameter accessibility level (on = menu "OPER" and "ConF"; off = menu "ConF" only).

The active Set Point and the alarm thresholds will only be visible on the Set Point fast programming level (described in par. 2.1) if the relative parameters are programmed to be visible (i.e. if they are present in the menu "OPER").

The possible modification of these Sets, with the procedure described in par. 2.1, is instead subordinate to what is programmed in par. "Edit" (contained in the group "1PAn").

This parameter can be programmed as:

=SE : The active Set Point can be modified while the alarm thresholds cannot be modified.

=AE : The active Set Point cannot be modified while the alarm thresholds can be modified

=SAE : Both the active Set Point and the alarm thresholds can be modified

=SAnE : Both the active Set Point and the alarm thresholds cannot be modified

2.4 - CONTROL STATES

The controller can act in 3 different ways : automatic control (rEG), control off (OFF) and manual control (OPLO).

The instrument is able to pass from one state to the other :

- by selecting the desired state from the main selection menu using the keyboard.

- By using the key "F" on the keyboard; suitably programming par. "USrb" ("USrb" = tunE; "USrb" = OPLO; "USrb" = OFF) it is possible to pass from "rEG" state to the state programmed on the parameter and vice versa.

- Automatically (the instrument swaps into "rEG" state at the end of the auto-tuning execution)

When switched on, the instrument automatically reassumes the state it was in when it was last switched off.

AUTOMATIC CONTROL (rEG) – Automatic control is the normal functioning state of the controller.

During automatic control it is possible to visualize the control power on the display by pushing key "UP".

The range of the power values goes from H100 (100% of the output power with reverse action) to C100 (100% of the output power with direct action).

CONTROL OFF (OFF) – The instrument can be swapped into the "OFF" state, i.e. the control and the relative outputs are deactivated.

The alarm outputs are instead working normally.

BUMPLESS MANUAL CONTROL (OPLO) – By means of this option it is possible to manually program the power percentage given as output by the controller by deactivating automatic control.

When the instrument is swapped to manual control, the power percentage is the same as the last one supplied and can be modified using the "UP" and "DOWN" keys.

As in the case of automatic control, the programmable values range from H100 (+100%) to C100 (-100%).

To return to automatic control, select "rEG" in the selection menu.

2.5 - ACTIVE SET POINT SELECTION

This instrument permits pre-programming of up to 4 different Set points ("SP1", "SP2", "SP3", "SP4") and then selection of which one must be active. The maximum number of Set points is determined by the par. "nSP" located in the group of parameters "1SP".

The active Set point can be selected :

- by parameter "SPAt" in the group of parameters "1SP".

- by key "F" if par. "USrb" = CHSP

- Automatically between SP1 and SP2 if a time "dur.t" (see par. 4.8) has been programmed.

Set Points "SP1", "SP2", "SP3", "SP4" will be visible depending on the maximum number of Set Points selected on par. "nSP" and they can be programmed with a value that is between the value programmed on par. "SPLL" and the one programmed on par. "SPHL".

Note : in all the following examples the Set point is indicated as "SP", however the instrument will act according to the Set point selected as active.

3 - INFORMATION ON INSTALLATION AND USE



3.1 - PERMITTED USE

The instrument has been projected and manufactured as a measuring and control device to be used according to EN61010-1 for the altitudes operation until 2000 ms.

The use of the instrument for applications not expressly permitted by the above mentioned rule must adopt all the necessary protective measures.

The instrument CANNOT be used in dangerous environments (flammable or explosive) without adequate protection.

The installer must ensure that EMC rules are respected, also after the instrument installation, if necessary using proper filters.

Whenever a failure or a malfunction of the device may cause dangerous situations for persons, thing or animals, please remember that the plant has to be equipped with additional devices which will guarantee safety.

3.2 – MECHANICAL MOUNTING

The instrument, in DIN case 48 x 48 mm, is designed for flush-in panel mounting.

Make a hole 45 x 45 mm and insert the instrument, fixing it with the provided special bracket.

We recommend that the gasket is mounted in order to obtain the front protection degree as declared. Avoid placing the instrument in environments with very high humidity levels or dirt that may create condensation or introduction of conductive substances into the instrument.

Ensure adequate ventilation to the instrument and avoid installation in containers that house devices which may overheat or which may cause the instrument to function at a higher temperature than the one permitted and declared.

Connect the instrument as far away as possible from sources of electromagnetic disturbances such as motors, power relays, relays, solenoid valves, etc.

The instrument can be removed from its housing from the front side : it is recommended that the instrument be disconnected from the power supply when it is necessary to carry out this operation.

3.3 - ELECTRICAL CONNECTION

Carry out the electrical wiring by connecting only one wire to each terminal, according to the following diagram, checking that the power supply is the same as that indicated on the instrument and that the load current absorption is no higher than the maximum electricity current permitted.

As the instrument is built-in equipment with permanent connection inside housing, it is not equipped with either switches or internal devices to protect against overload of current: the installation will include a two-phase circuit-breaker, placed as near as possible to the instrument, and located in a position that can easily be reached by the user and marked as instrument disconnecting device which interrupts the power supply to the equipment.

It is also recommended that all the electrical circuits connected to the instrument must be protect properly, using devices (ex. fuses) proportionate to the circulating currents.

It is strongly recommended that cables with proper insulation, according to the working voltages and temperatures, be used.

Furthermore, the input cable of the probe has to be kept separate from line voltage wiring. If the input cable of the probe is screened, it has to be connected to the ground with only one side.

We recommend that a check should be made that the parameters are those desired and that the application functions correctly before connecting the outputs to the actuators so as to avoid malfunctioning that may cause irregularities in the plant that could cause damage to people, things or animals.

OSAKA and its legal representatives do not assume any responsibility for any damage to people, things or animals deriving from violation, wrong or improper use or in any case not in compliance with the instrument's features.

3.4 - ELECTRICAL WIRING DIAGRAM

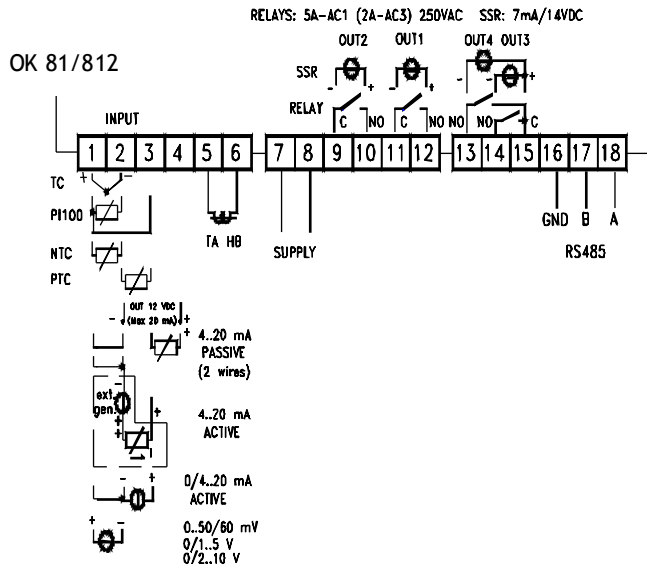

4 - FUNCTIONS

4.1 - MEASURING AND VISUALIZATION

All the parameters referring measurements are contained in the group "InP".

By using par. "HCFG", it is possible to select the input signal type which may come: from a thermocouple (tc), a thermo-resistance or a thermistor (rt), from a transducer with normalised analogue signal in current (I) or tension (UoIt) or also from a signal coming from the communication serial line of the instrument (SER).

Once the signal type has been selected, it is necessary to set the type of input probe on par. "SEnS", which can be :

- for thermocouples J (J), K (CrAl), S (S) or for infra-red sensors series OSAKA IRTC1 with linearization J (Ir.J) or K (Ir.CA)
- for thermo-resistances Pt100 IEC (Pt1) or thermistors PTC KTY81-121 (Ptc) or NTC 103AT-2 (ntc)
- for normalised signals in current 0.20 mA (0.20) or 4.20 mA (4.20)
- for normalised signals in voltage 0.50 mV (0.50), 0.60 mV (0.60), 12.60 mV (12.60), 0.5 V (0.5), 1.5 V (1.5), 0.10 V (0.10) or 2.10 V (2.10).

We recommend that the instrument be switched on and off whenever these parameters are modified, in order to obtain a correct measurement.

For the instruments with input for temperature probes (tc, rtd) it is possible to select the unit of measurement (°C, °F) through par. "Unit", and the desired resolution (0=1°; 1=0,1°) through par. "dP". Instead, with regards to the instruments with normalised analogue input signals, it is first necessary to program the desired resolution on par. "dP" (0=1; 1=0,1; 2=0,01; 3=0,001) and then, on par. "SSC", the value that the instrument must visualise at the beginning of the scale (0/4 mA, 0/12 mV, 0/1 V or 0/2 V) and, on par. "FSC", the value that the instrument must visualise at the end of the scale (20 mA, 50 mV, 60 mV, 5 V or 10 V).

The instrument allows for measuring calibration, which may be used to recalibrate the instrument according to application needs, by using par. "OFSt" and "rot".

Programming par. "rot"=1,000, in par. "OFSt" it is possible to set a positive or negative offset that is simply added to the value read by the probe before visualisation, which remains constant for all the measurements.

If instead, it is desired that the offset set should not be constant for all the measurements, it is possible to operate the calibration on any two points.

In this case, in order to decide which values to program on par. "OFSt" and "rot", the following formulae must be applied :

$$\text{"rot"} = (D2-D1) / (M2-M1) \quad \text{"OFSt"} = D2 - (\text{"rot"} \times M2)$$

where:

- M1 =measured value 1
- D1 = visualisation value when the instrument measures M1
- M2 =measured value 2
- D2 = visualisation value when the instrument measures M2

It then follows that the instrument will visualise :

$$DV = MV \times \text{"rot"} + \text{"OFSt"}$$

where: DV = visualised value MV= measured value

Example 1: It is desired that the instrument visualises the value effectively measured at 20° but that, at 200°, it visualises a value lower than 10° (190°).

Therefore : M1=20 ; D1=20 ; M2=200 ; D2=190

"rot" = (190 - 20) / (200 - 20) = 0,944

"OFSt" = 190 - (0,944 x 200) = 1,2

Example 2: It is desired that the instrument visualises 10° whilst the value actually measured is 0°, but, at 500° it visualises a 50° higher value (550°).

Therefore : M1=0 ; D1=10 ; M2=500 ; D2=550

"rot" = (550 - 10) / (500 - 0) = 1,08

"OFSt" = 550 - (1,08 x 500) = 10

By using par. "FIL" it is possible to program time constant of the software filter for the input value measured, in order to reduce noise sensitivity (increasing the time of reading).

In case of measurement error, the instrument supplies the power as programmed on par. "OPE".

This power will be calculated according to cycle time programmed for the PID controller, while for the ON/OFF controllers the cycle time is automatically considered to be equal to 20 sec. (e.g. In the event of probe error with ON/OFF control and "OPE"=50, the control output will be activated for 10 sec., then it will be deactivated for 10 sec. and so on until the measurement error remains.).

By using par. "InE" it is also possible to decide the conditions of the input error, allowing the instrument to give the power programmed on par. "OPE" as output.

The possibilities of par. "InE" are :

= Or : the condition occurs in case of over-range or probe breakage

= Ur : the condition occurs in case of under-range or probe breakage

= Our : the condition occurs in case of over-range or under-range or probe breakage

Using par. "diSP", located in the group "PAN", it is possible to set normal visualization of the display which can be the process variable (dEF), the control power (Pou), the active Set Point (SP.F) the Set Point operating when there are active ramps (SP.o) or alarm threshold AL1, 2 or 3 (AL1, AL2 or AL3).

Again in the group "PAN" the par. "AdE" is present that defines the 3 led shift index functioning.

The lighting up of the green led = indicates that the process value is within the range [SP+AdE ... SP-AdE], the lighting up of the led - indicates that the process value is lower than [SP-AdE] and the lighting up of the led + indicates that the process value is higher than [SP+AdE].

4.2 - OUTPUTS CONFIGURATION

The instrument's outputs can be programmed by entering the group of parameters "Out", where the relative parameters "O1F", "O2F", "O3F", "O4F" (depending on the number of outputs available on the instrument) are located.

The outputs can be set for the following functions :

- Main control output (1.rEG)
- Secondary control output (2.rEG)
- Alarm output normally open (ALno)
- Alarm output normally closed (ALnc)
- Output deactivated (OFF)

The coupling outputs number outputs - number alarms can be made in the group referring to the alarm to the alarm ("AL1", "AL2" or "AL3").

4.3 - ON/OFF CONTROL (1rEG)

All the parameters referring to the ON/OFF control are contained in the group "rEG".

This type of control can be obtained by programming par. "Cont" = On.FS or = On.FA and works on the output programmed as 1.rEG, depending on the measure, on the active Set Point "SP", on the functioning mode "Func" and on the hysteresis "HSEt".

The instrument carries out an ON/OFF control with symmetric hysteresis if "Cont" = On.FS or with asymmetrical hysteresis if "Cont" = On.Fa.

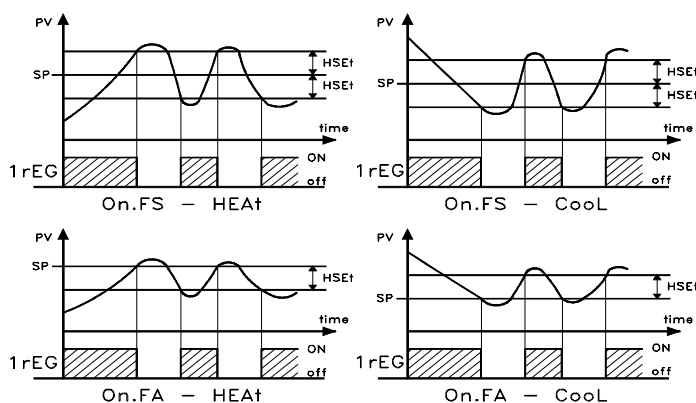

The control works in the following way : in the case of reverse action, or heating ("Func"=HEAT), it deactivates the output, when the process value reaches [SP + HSEt] in case of symmetrical hysteresis, or [SP] in case of asymmetrical hysteresis and is then activated again when the process value goes below value [SP - HSEt].

Vice versa, in case of direct action or cooling ("Func"=Cool), it deactivates the output, when the process value reaches [SP - HSEt] in case of symmetrical hysteresis, or [SP] in case of asymmetrical hysteresis and is activated again when the process value goes above value [SP + HSEt].

4.4 - NEUTRAL ZONE ON/OFF CONTROL (1rEG - 2rEG)

All the parameters referring to Neutral Zone ON/OFF control are contained in the group "rEG".

This type of control can be obtained when 2 outputs are programmed respectively as 1rEG and 2rEG and the par. "Cont" = nr .

The Neutral Zone control is used to control plants in which there is an element which causes a positive increase (ex. Heater, humidifier, etc.) and an element which causes a negative increase (ex. Cooler, de-humidifier, etc.).

The control functions works on the programmed outputs depending on the measurement, on the active Set Point "SP" and on the hysteresis "HSEt".

The control works in the following way : it deactivates the outputs when the process value reaches the Set Point and it activates the output 1rEG when the process value goes below value [SP - HSEt], or it activates the output 2rEG when the process value goes above [SP + HSEt].

Consequently, the element causing a positive increase has to be connected to the output programmed as 1rEG while the element causing a negative increase has to be connected to the output programmed as 2rEG.

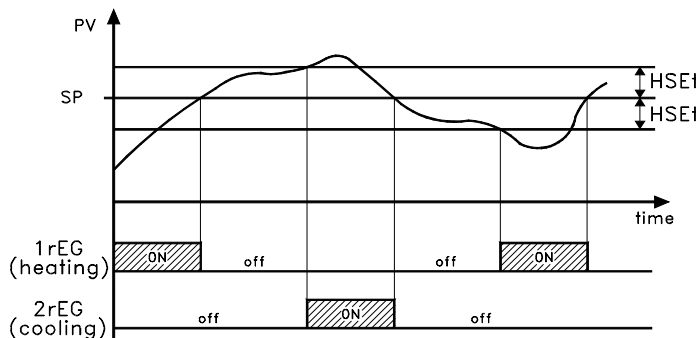

4.5 - SINGLE ACTION PID CONTROL (1rEG)

All the parameters referring to PID control are contained in the group "rEG".

The Single Action PID control can be obtained by programming par. "Cont" = Pid and works on the output 1rEG depending on the

active Set Point "SP", on the functioning mode "Func" and on the instrument's PID algorithm with two degree of freedom.

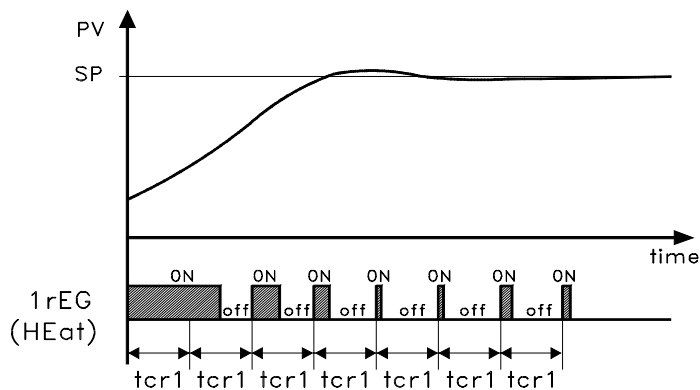

In order to obtain good stability of the process variable, in the event of fast processes, the cycle time "tcr1" has to have a low value with a very frequent intervention of the control output.

In this case use of a solid state relay (SSR) is recommended for driving the actuator.

The Single Action PID control algorithm foresees the setting of the following parameters :

"Pb" – Proportional Band

"tcr1" – Cycle time of the output 1rEG

"Int" – Integral Time

"rS" – Manual Reset (if "Int =0 only)

"dEr" – Derivative Time

"FuOC" - Fuzzy Overshoot Control

This last parameter allows the variable overshoots at the start up of the process or at the changing of the Set Point to be avoided.

Please remember that a low value on this parameter reduces the overshoot while a high value increase it.

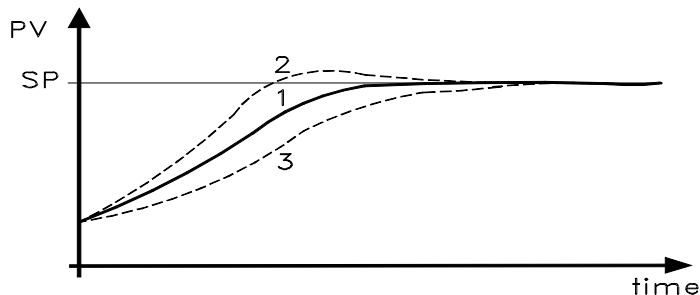

1: Value "FuOC" OK

2: Value "FuOC" too high

3: Value "FuOC" too low

4.6 - DOUBLE ACTION PID CONTROL (1rEG - 2rEG)

All the parameters referring to PID control are contained in the group "1rEG".

The Double Action PID control is used to control plants where there is an element which causes a positive increase (ex. Heating) and an element which causes a negative increase (ex. Cooling).

This type of control can be obtained when 2 outputs are programmed respectively as 1rEG and 2rEG and the par. "Cont" = Pid.

The element causing a positive increase has to be connected to the output programmed as 1rEG while the element causing a negative increase has to be connected to the output programmed as 2rEG.

The Double Action PID control works on the outputs 1rEG and 2rEG depending on the active Set Point "SP" and on the instrument's PID algorithm with two degrees of freedom.

In order to obtain good stability of the process variable, in case of fast processes, the cycle times "tcr1" and "tcr2" have to have a low value with a very frequent intervention of the control outputs.

In this case use of solid state relays (SSR) to drive the actuators is recommended.

The Double Action PID control algorithm needs the programming of the following parameters :

"Pb" – Proportional Band

"tcr1" – Cycle time of the output 1rEG

"tcr 2" – Cycle time of the output 2rEG

"Int" – Integral Time

"rS" – Manual Reset (if "Int =0 only)

"dEr" – Derivative Time

"FuOC" - Fuzzy Overshoot Control

"Prat" - Power Ratio or relation between power of the element controlled by output 2rEG and power of the element controlled by output 1rEG.

If par. "Prat" = 0, the output 2rEG is disabled and the control behaves exactly as a single action PID controller, through output 1rEG.

4.7 - AUTOTUNING AND SELFTUNING FUNCTIONS

All the parameters referring to the AUTO-TUNING and SELF-TUNING functions are contained in the group "1rEG".

The AUTO-TUNING and SELF-TUNING functions permit the automatic tuning of the PID controller.

The **AUTO-TUNING** function permits the calculation of the PID parameters by means of a FAST type tuning cycle and, at the end of this operation, the parameters are stored into the instrument's memory and remain constant during control.

The **SELF-TUNING** function (rule based "TUNE-IN") instead allows control monitoring and the continuous calculation of the parameters during control.

Both functions automatically calculate the following parameters :

"Pb" – Proportional Band

"tcr1" – Cycle time of the output 1rEG

"Int" – Integral Time

"dEr" – Derivative Time

"FuOC" - Fuzzy Overshoot Control

and, for the Double Action PID control, also :

"tcr 2" – Cycle time of the output 2rEG

"Prat" - Ratio P 2rEG/ P 1rEG

To activate the AUTO-TUNING function proceed as follows :

- 1) Program and activate the desired Set Point.
 - 2) Program par. "Cont" =Pid.
 - 3) Program par. "Func" according to the process to be controlled through output 1rEG.
 - 4) Program an output as 2rEG if the instrument controls a plant with double action
 - 5) Program par. "Auto" as:
 - "1" – if auto-tuning is desired automatically, each time the instrument is switched on, on the condition that the process value is lower (with "Func" =HEAT) than $[SP - |SP/2|]$ or higher (with "Func" =Cool) than $[SP + |SP/2|]$.
 - "2" – if auto-tuning is desired automatically, the next time the instrument is switched on, on the condition that the process value is lower (with "Func" =HEAT) than $[SP - |SP/2|]$ or higher (with "Func" =Cool) than $[SP + |SP/2|]$, and once the tuning is finished, the par. "Auto" is automatically swapped to the OFF state
 - "3" - if manual auto-tuning is desired, by selecting par. "tunE" in the main menu or by correctly programming key "F" as "USrb" = tunE. In this case the auto-tuning starts without any control on the process value condition. It is recommended to use this option, starting the auto-tuning when the process value is as far as possible from the Set Point because, in order to feature the Auto-tuning FAST with its best performances , it is preferable to respect this condition.
 - "4" - if it's desired to activate the autotuning automatically at the end of programmed Soft-Start cycle. The Autotuning will start at the condition that the process value is lower (with "Func" =HEAT) than $[SP - |SP/2|]$ or higher (with "Func" =Cool) than $[SP + |SP/2|]$.
 - 6) Exit from the parameter programming.
 - 7) Connect the instrument to the controlled plant.
 - 8) Activate the Auto-tuning by selecting par. "tunE" in the main menu (or by correctly programming key "F").
- At this point the Auto-tuning function is activated and is indicated by the flashing led AT/ST.
- The regulator carries out several operations on the connected plant in order to calculate the most suitable PID parameters.

If "Auto" = 1 or "Auto" = 2, and if, at the Auto-tuning start, the condition for the lower process value is not found (with "Func" =HEAT) than [SP- |SP/2]] or higher (with "Func" =CoolL) than [SP+ |SP/2]], the display will show "ErAt" and the instrument will be swapped to normal control conditions according to the previously programmed parameters.

To make the error "ErAt" disappear, swap the instrument to the OFF control (OFF) and then turn it to automatic control (rEG).

The Auto-tuning cycle duration has been limited to 12 hours maximum.

If Auto-tuning is not completed within 12 hours, the instrument will show "noAt" on the display.

In case of probe error, the instrument automatically stops the cycle in progress.

The values calculated by Auto-tuning are automatically stored in the instrument's memory at the end of the correct PID parameters tuning.

Note : The instrument is already programmed in our factory to carry out auto-tuning at every instrument switch on ("Auto" = 1).

To activate the SELF-TUNING function proceed as follows

- 1) Program and activate the desired Set Point.
- 2) Program par. "Cont" =Pid.
- 3) Program par. "Func" according to the process to be controlled through output 1rEG.
- 4) Program an output as 2rEG if the instrument controls a dual-action plant
- 5) Program par. "SELF" = yES
- 6) Exit from the parameter programming.
- 7) Connect the instrument to the controlled plant.
- 8) Activate Self-tuning selecting par. "tunE" in the main menu (or by correctly programming key "F").

When the Self-tuning function is active, the led AT/ST is permanently lit up and all the PID parameters ("Pb", "Int", "dEr", etc.) are no longer visualized.

To stop the Auto-tuning cycle or deactivate the Self-tuning function select one of the control types : "reG", "OPLO" or "OFF" from the menu "SEL". If the instrument is switched off during Auto-tuning or with the Self-tuning function activated, these functions will remain activated the next time it is switched on.

4.8 - REACHING OF THE SET POINT AT CONTROLLED SPEED AND AUTOMATIC SWITCHING BETWEEN TWO SET POINTS (RISE RAMP, FALL RAMP AND DWELL TIME)

All the parameters referring to the ramps functioning are contained in the group "rEG".

It is possible to reach the set point in a predetermined time (in any case longer than the time the plant would naturally need). This could be useful in those processes (heating or chemical treatments, etc.) where the set point has to be reached gradually, in a predetermined time.

Once the instrument has reached the first Set Point (SP1) it is possible to have automatic switching to the second Set Point (SP2) after a set time, thus obtaining a simple automatic thermic cycle.

These functions are available for all the programmable controls (PID single and double action, ON/OFF and Neutral Zone ON/OFF).

The function is determined by the following parameters :

"SLor" - Gradient of rise ramp (Process value < Set point) expressed in unit/minute

"SLoF" - Gradient of fall ramp (Process value > Set point) expressed in unit/minute.

"dur.t" – Dwell time of Set Point SP1 before automatic switching to Set Point 2 SP2 (expressed in hrs. and min.).

The functions are deactivated when the relative parameters are = InF.

When the Set Point value is changed or at switch on, the instrument automatically determines which of the two values "SLor" or "SLoF" it has to use.

Note: In case of PID control, if Auto-tuning is desired whilst the ramp function is active, this will not be carried out until the tuning cycle has been completed.

It is therefore recommended that Auto-tuning be started avoiding activating the ramp function and, once the tuning is finished, deactivate Auto-tuning ("Auto" = OFF), program the desired ramps and, if it automatic tuning is desired, enable the Self-tuning function.

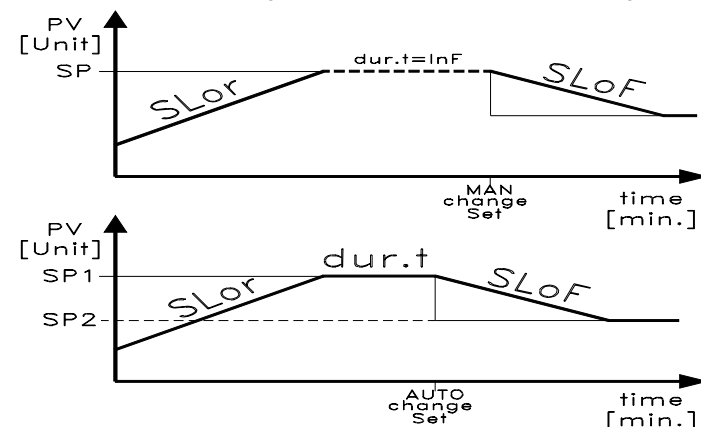

Examples with starts from values lower than SP and with decreasing of SP.

4.9 - SOFT-START FUNCTION

All the parameters referring to the Soft -Start functioning are contained in the group "rEG".

The Soft-Start function only works through PID control and allows the limitation of control power when the instrument is switched on, for a programmable period of time.

This is useful when the actuator, driven by the instrument, may be damaged excess power supplied when the application is not yet in the normal rating. (ex. for certain heating elements).

The function depends on the following parameters :

"St.P" – Soft-Start power

"Sst" – Soft-Start time (expressed in hh.mm)

The possible function modes are the following :

1) If both parameters are programmed with values other than OFF, when switched on the instrument gives an output power as programmed on par. "St.P" for the time programmed on par. "Sst". Practically, the instrument works in manual condition and switches to automatic control at the elapsing of time "Sst".

It is advisable not to program a power "St.P" that is too high as the function is not deactivated when the automatic control power is found to be lower than the programmed one.

2) If par. "St.P" = OFF and a value is set on par. "Sst", at the switch on, the power calculated by the PID controller is divided by the time "Sst", in order to calculate a ramp. The output power starts from 0 and is progressively increased, depending on the calculated ramp, until the "Sst" time is reached or until the power overcomes the power calculated by the PID controller.

To disable the Soft-Start function simply program par. "Sst" = OFF. Whenever, a measurement errors occurs during the Soft-Start execution, the function is interrupted and the instrument gives an output power as programmed on par. "OPE".

If the measurement is restored, the Soft-Start is still deactivated.

If it's desired to activate the Autotuning with Soft-Start set par. "Auto"=4.

The Autotuning will start automatically at the end of programmed Soft-Start cycle at the condition that the process value is lower (with "Func" =HEAT) than [SP- |SP/2]] or higher (with "Func" =CoolL) than [SP+ |SP/2]].

4.10 - ALARM FUNCTION (AL1, AL2, AL3)

4.10.1 - ALARM OUTPUT CONFIGURATION

The alarms (AL1, AL2, AL3) depend on the process value and before setting them to work, it is necessary to know which output the alarm has to correspond to.

First of all it is necessary to configure the parameters relative to the outputs required as alarm ("O1F", "O2F", "O3F", "O4F"), in the

group of parameters "Out", programming the parameter relating to the desired output as follows :

= **ALno** if the alarm output has to be ON when the alarm is active, while it is OFF when the alarm is not active

= **ALnc** if the alarm output has to be ON when the alarm is not active, while it is OFF when the alarm is active

Note: In the following examples the alarm's number is generally indicated as **n**

Access the group "**ALn**", relating to the alarm to be set and program which output the alarm signal must be sent to on par. "**OALn**".

The alarm functioning is instead defined by parameters :

"ALnt" – ALARM TYPE

"Abn" – ALARM CONFIGURATION

"ALn" – ALARM THRESHOLD

"ALnL" – LOW ALARM THRESHOLD (for band alarm) OR MINIMUM SET OF ALn ALARM THRESHOLD (for low or high alarm)

"ALnH" – HIGH ALARM THRESHOLD (for band alarm) OR MAXIMUM SET OF ALn ALARM THRESHOLD (for low or high alarm)

"HALn" - ALARM HYSTERESIS

"ALnd" – ALARM ACTIVATION DELAY (in sec.)

"ALni" – ALARM BEHAVIOUR IN THE EVENT OF MEASUREMENT ERROR

"ALnt" – **ALARM TYPE** : the alarm output can behave in six different ways.

LoAb = ABSOLUTE LOW ALARM: The alarm is activated when the process value goes below the alarm threshold set on parameter "ALn". With this mode is possible to program the minimum and the maximum set of "ALn" by "ALnL" and "ALnH" parameters.

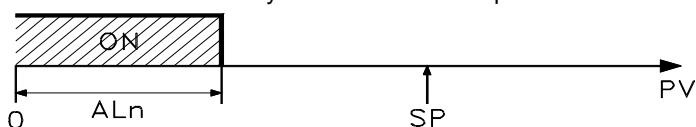

HiAb = ABSOLUTE HIGH ALARM: The alarm is activated when the process value goes higher than the alarm threshold set on parameter "ALn". With this mode is possible to program the minimum and the maximum set of "ALn" by "ALnL" and "ALnH" parameters.

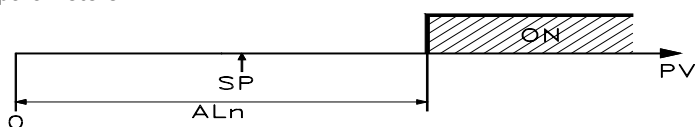

LHAb = ABSOLUTE BAND ALARM: The alarm is activated when the process value goes under the alarm threshold set on parameter "ALnL" or goes higher than the alarm threshold set on parameter "ALnH".

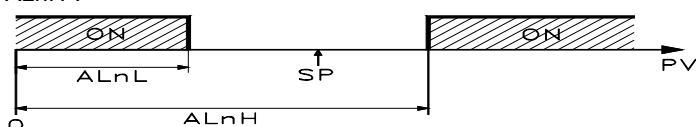

LodE = DEVIATION LOW ALARM: The alarm is activated when the process value goes below the value [SP + ALn]. With this mode is possible to program the minimum and the maximum set of "ALn" by "ALnL" and "ALnH" parameters.

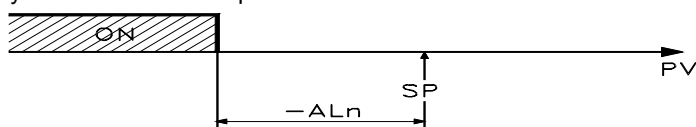

HiE = DEVIATION HIGH ALARM: The alarm is activated when the process value goes above the value [SP + ALn]. With this mode is possible to program the minimum and the maximum set of "ALn" by "ALnL" and "ALnH" parameters.

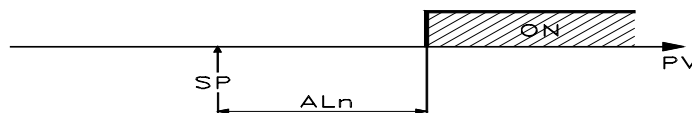

LHdE = DEVIATION BAND ALARM: The alarm is activated when the process value goes below the value [SP + ALnL] or goes above than the value [SP + ALnH]

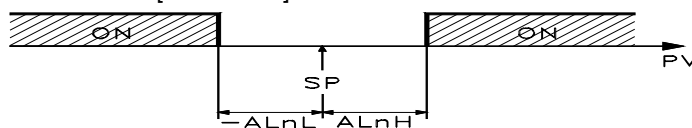

"Abn" - ALARM CONFIGURATION: This parameter can assume a value between 0 and 15.

The number to be set, which will correspond to the function desired, is obtained by adding the values reported in the following descriptions :

ALARM BEHAVIOUR AT SWITCH ON: the alarm output may behave in two different ways, depending on the value added to par. "Abn".

+0 = **NORMAL BEHAVIOUR:** The alarm is always activated when there are alarm conditions.

+1 = **ALARM NOT ACTIVATED AT SWITCH ON:** If, when switched on, the instrument is in alarm condition, the alarm is not activated. It will be activated only when the process value is in non-alarm conditions and then back in alarm conditions.

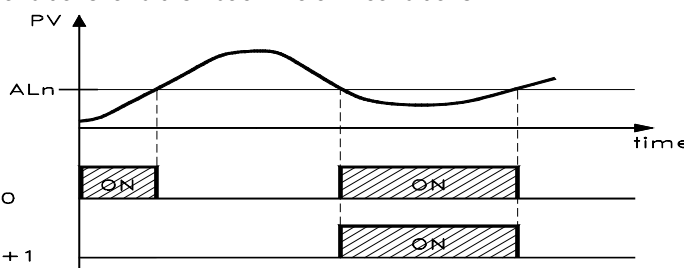

(Example with minimum Alarm)

ALARM DELAY: the alarm output may behave in two different ways depending on the value added to par. "Abn".

+0 = **ALARM NOT DELAYED:** The alarm is immediately activated when the alarm condition occurs.

+2 = **ALARM DELAYED:** When the alarm condition occurs, delay counting begins, as programmed on par. "ALnd" (expressed in sec.) and the alarm will be activated only after the elapsing of that time.

ALARM LATCH: : the alarm output may behave in two different ways depending on the value added to par. "Abn".

+0 = **ALARM NOT LATCHED:** The alarm remains active in alarm conditions only.

+4 = **ALARM LATCHED:** The alarm is active in alarm conditions and remains active even when these conditions no longer exist, until the correctly programmed key "F", ("USrb"=Aac) has been pushed.

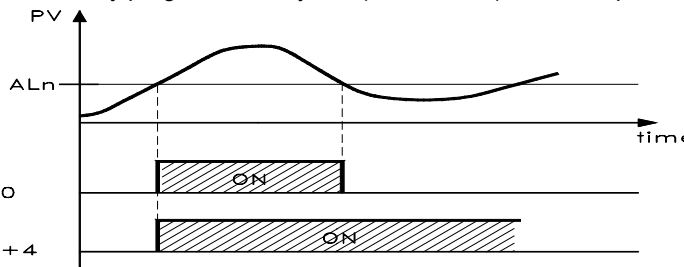

(Example with maximum Alarm)

ALARM AKNOWLEDGEMENT: : the alarm output may behave in two different ways depending on the value added to par. "Abn".

+0 = **ALARM NOT AKNOWLEDGED:** The alarm always remains active in alarm conditions.

+8 = **ALARM AKNOWLEDGED:** The alarm is active in alarm conditions and can be deactivated by key "F" if properly programmed ("USrb"=ASi), and also if alarm conditions still exist.

"ALni" - ALARM ACTIVATION IN CASE OF MEASUREMENT

ERROR: This allows one to establish how the alarm have behave in the event of a measurement error (yES=alarm active; no=alarm deactivated).

4.10.2 - ALARMS HYSTERESIS

The alarm function depend s on alarm hysteresis (par. "HALn"), which works in asymmetric way.

In the event of low alarm, the alarm will be activated when the process value goes below the alarm threshold value and will be deactivated when it goes above the alarm threshold + "HALn" ; in case of high alarm, the alarm will be activated when the process value goes above the alarm threshold value and will be deactivated when it goes below the alarm threshold - "HALn".

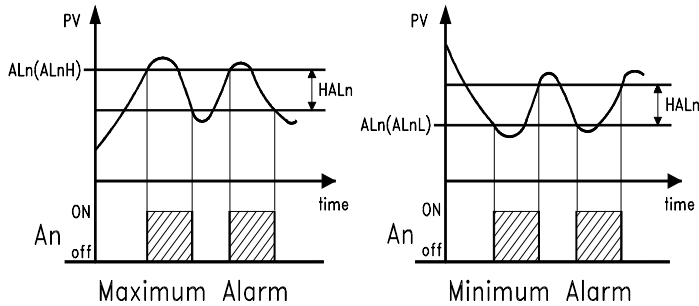

For the band alarms, the example of the low alarm is applicable to the low threshold ("ALnL") while the example of the high alarm is applicable to the high threshold ("ALnH").

4.11 - HEATER BREAK ALARM FUNCTION (HB)

All the parameters referring to the Heater Break alarm function are contained in the group "Hb".

The Heater Break alarm function (Breakage of the heating element) is only available when the instrument is equipped with the input (TAHB) to measure the current.

This input accepts signals coming from current transformers (TA) with max. output 50 mA.

The first operation to be carried out in order to obtain a correct current measurement, is to set the current that the instrument has to measure at the end of scale of the input TA (50 mA) on par. "IFS".

It is necessary to establish to which output the alarm has to correspond.

To do this it is necessary to set the parameter relative to the output to be used ("O1F", "O2F", "O3F", "O4F") in the group "Out", programming the parameter as :

= **ALno** if the alarm output has to be active when the alarm is active while it is deactivated when the alarm is not active.

= **ALnc** if the alarm output has to be active when the alarm is not active while it is deactivated when the alarm is active.

Enter group "Hb" and program which output the alarm signal has to address on parameter "OHb".

The functioning mode of the alarm is instead defined on par. "HbF" which can be set in the following way :

= 1 : The alarm is active when, with output 1rEG active, the current measured by the input TAHB is lower than the value programmed on par. "IHbL".

= 2 : The alarm is active when, with output 1rEG not active, the current measured by the input TAHB is higher than the value programmed on par. "IHbH".

= 3 : The alarm is active when, with output 1rEG active, the current measured by the input TAHB is lower than the value programmed on par. "IHbL" or with output 1rEG not active, the current measured by the input TAHB is higher than the value programmed on par. "IHbH".

= 4 : The alarm is active when the current measured by the input TAHB is lower than the value programmed on par. "IHbL" or the measured current is higher than the value programmed on par. "IHbH", independently by the state of the output 1rEG.

On par. "IHbL" the value of the current normally absorbed by the load when output 1rEG is active has to be set, while on par. "IHbH"

the current normally absorbed by the load when output 1rEG is not active.

The programming of these parameters has to be carried out while also considering the fluctuations of the net voltage to avoid undesired alarms.

With regards to the hysteresis of the HB alarm, this is automatically calculated by the instrument as 1% of the programmed thresholds.

During functioning it is possible to visualize the current measured by the input TAHB when output 1rEG is activated, by pushing the "DOWN" key and the current measured when output 1rEG is deactivated, by pushing the "DOWN" and "F" keys at the same time. To exclude the Heater Break alarm it is enough to set "OHb" = OFF.

Note : The HB current measurement is valid if the output 1rEG is activated (or deactivated) for 264 ms. at least.

This means that, if the cycle time ("tcr1") is = 1 sec, the HB alarm is able to intervene only when the output power is higher than 26,4%.

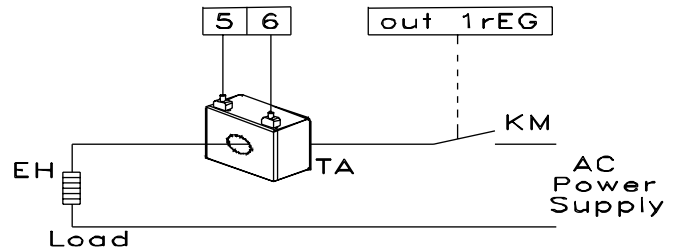

4.12 - LOOP BREAK ALARM FUNCTION

All the parameters referring to the Loop Break alarm function are contained in the group "LbA".

The Loop Break alarm is available on all the instruments, which intervenes when, for any reason (short-circuit of a thermocouple, thermocouple inversion, load interruption), the loop control is interrupted.

First of all, it is necessary to establish to which output the alarm has to correspond.

To do this it is necessary to set the parameter relative to the output to be used ("O1F", "O2F", "O3F", "O4F") in the group "Out", programming the parameter as :

= **ALno** if the alarm output has to be ON when the alarm is active while it is OFF when the alarm is not active.

= **ALnc** if the alarm output has to be ON when the alarm is not active while it is OFF when the alarm is active.

Enter group "LbA" and program which output the alarm signal has to be addressed to on par. "OLbA".

The Loop Break alarm is activated if the output power remains at the 100% of the value for the time programmed on par. "LbAt" (expressed in sec.).

To avoid false alarms, the value of this parameter has to be set considering the time the plant takes to reach the Set point when the measured value is a long distance from it (for example at the plant start-up).

On alarm intervention, the instrument visualizes the message "LbA" and behaves as in the case of a measurement error giving a power output as programmed on par. "OPE" (programmable in the group "InP").

To restore normal functioning after the alarm, select the control mode "OFF" and then re-program the automatic control ("rEG") after checking the correct functioning of probe and actuator.

To exclude the Loop Break alarm, set "OLbA" = OFF.

4.13 - FUNCTIONING OF KEY "F"

The function of key "U" can be set through par. "USrb" contained in the group "Pan".

The parameter can be programmed as :

= **noF** : no function

= **tunE** : Pushing the key for 1 sec. at least, it is possible to activate/deactivate Auto-tuning or Self-tuning

= **OPLO** : Pushing the key for 1 sec. at least, it is possible to swap from automatic control (rEG) to manual one (OPLO) and vice versa.

- = **Aac** : Pushing the key for 1 sec. at least, it is possible to acknowledge the alarm. (see par. 4.10.1)
- = **ASi** : Pushing the key for 1 sec. at least, it is possible to acknowledge an active alarm (see par. 4.10.1)
- = **CHSP** : Pushing the key for 1 sec. at least, it is possible to select one of the 4 pre-programmed Set Points on rotation.
- = **OFF** : Pushing the key for 1 sec. at least, it is possible to swap from automatic control (rEG) to OFF control (OFF) and vice versa.

4.14 - RS 485 SERIAL INTERFACE

The instrument can be equipped with a RS 485 serial communication interface, by means of which it is possible to connect the regulator with a net to which other instruments (regulators of PLC) are connected, all depending typically on a personal computer used as plant supervisor. Using a personal computer it is possible to acquire all the function information and to program all the instrument's configuration parameters. The software protocol adopted for OK 81 is a MODBUS RTU type, widely used in several PLC and supervision programs available on the market (OK 81 protocol manual is available on request).

The interface circuit allows the connection of up to 32 instruments on the same line.

To maintain the line in rest conditions a 120 Ohm resistance (Rt) must be connected to the end of the line.

The instrument is equipped with two terminals called A and B which have to be connected with all the namesake terminals of the net. For the wiring operation they must be interlaced with a double cable (telephonic type) and all the GND terminals must be connected to the ground. Nevertheless, particularly when the net results very long or noised and being present potential differences between the GND terminals, it is advisable to adopt a screened cable wired as in the drawing.

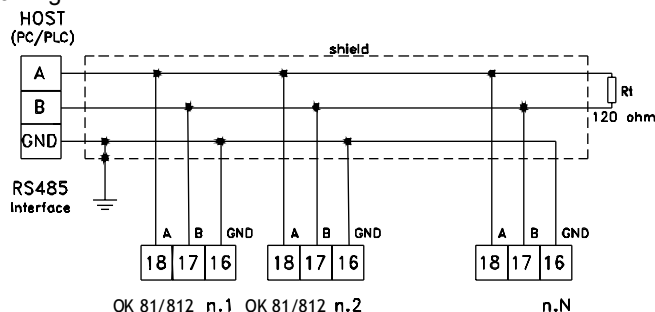

If the instrument is equipped with a serial interface, the parameters to be programmed are the following, all present in the parameters group "**SEr**":

"Add" : Address of the station. Set a different number for each station, from 1 to 255.

"baud" : Transmission speed (baud-rate), programmable from 1200 to 38400 baud. All the stations have to have the same transmission speed.

"PACS" : Programming access. If programmed as "LoCL" this means that the instrument is only programmable from the keyboard, if programmed as "LorE" it is programmable both from the keyboards and serial line.

If an attempt is made to enter the programming from the keyboard whilst a communication through the serial port is in progress the instrument will visualise "**buSy**" to indicate the busy state.

4.15 - PARAMETERS CONFIGURATION BY "KEYPC"

The instrument is equipped with a connector that allows the transfer from and toward the instrument of the functioning parameters through the device OSAKA **KEYPC** with **3 poles** connector.

This device it's mainly useable for the serial programming of the instruments which need to have the same parameters configuration or to keep a copy of the programming of an instrument and allow its rapid retransmission.

To use the device **KEYPC** it's necessary that both device and instrument are being supplied.

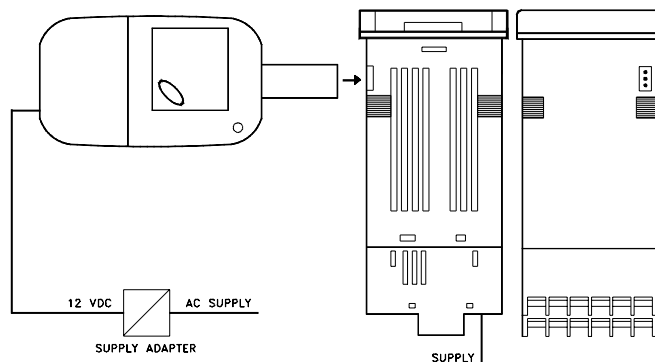

P.A.: For the instruments equipped with RS485 serial communication, it's indispensable that the parameter "PACS" is programmed = LorE.

To transfer the configuration of an instrument into the device (**UPLOAD**) it is necessary to proceed in the following way:

- 1) position both dip switch of KEY PC in the **OFF** mode.
- 2) connect the device to the instrument OK plugging the special connector.
- 3) verify that the instrument and the device are supplied
- 4) observe the indication led on the device KEY PC: if it results green this means that a configuration is already loaded on the device while if it results green blinking or red blinking this means that it has not been loaded any valid configuration on the device .
- 5) press the button placed on the device.
- 6) observe the indication led : after having pressed the button, the led becomes red and therefore, at the end of the data transfer, it becomes green.
- 7) now it is possible to disconnect the device.

To transfer the configuration loaded on the device onto an instrument of the same family (**DOWNLOAD**), it is necessary to proceed in the following way:

- 1) position both dip switch of KEY PC in the **ON** mode.
- 2) connect the device to an instrument OK having the same features of the one from which has been downloaded the desired configuration, plugging the special connector.
- 3) verify that the instrument and the device are supplied
- 4) observe the indication led on the device KEY PC: it has to result green, because if the led results green blinking or red blinking, this means that on the device it has not been downloaded any valid configuration and therefore it's useless to continue.
- 5) if the les results green, press the button placed on the device.
- 6) observe the indication led : after having pressed the button, the led becomes red and therefore, at the end of the data transfer, it becomes green.
- 7) now it is possible to disconnect the device.

For additional info, please have a look at the **KEYPC** instruction manual.

5 - PROGRAMMABLE PARAMETERS

Here following are described all the parameters available on the instrument. Some of them could be not present or because they are depending on the type of instrument or because they are automatically disabled as unnecessary.

5.1 - PARAMETERS TABLE

Group "**SP**" (parameters relative to the Set Point)

Par.	Description	Range	Def.	Note
1	nSP Number of the programmable Set point	1 ÷ 4	1	
2	SPAt Active Set point	1 ÷ nSP	1	
3	SP1 Set Point 1	SPLL ÷ SPHL	0	
4	SP2 Set Point 2	SPLL ÷ SPHL	0	

5	SP3	Set Point 3	SPLL ÷ SPHL	0	
6	SP4	Set Point 4	SPLL ÷ SPHL	0	
7	SPLL	Low Set Point	-1999 ÷ SPHL	-1999	
8	SPHL	High Set Point	SPLL ÷ 9999	9999	

Group "InP" (parameters relative to the measure input)

Par.	Description	Range	Def.	Note
9	HCFG	Input type	tc / rtd / I / UoLt	tc
10	SEnS	Probe type	tc : J / CrAL / S / Ir.J / Ir.CA rtd : Pt1 / Ptc / ntc L : 0.20 / 4.20 UoLt : 0.50 / 0.60 / 12.60 / 0.5 / 1.5 / 0.10 / 2.10	J
11	SSC	Low scale limit in case of input with V / I signals	-1999 ÷ FSC	0
12	FSC	High scale limit in case of input with V / I signals	SSC ÷ 9999	0
13	dP	Number of decimal figures	tc/rtd : 0 / 1 UoLt / I / SEr: 0 ÷ 3	0
14	Unit	Temperature unit of measurement	tc/rtd : °C / °F	°C
15	FiL	Input digital filter <input type="checkbox"/>	OFF ÷ 20.0 sec.	0.2
16	OFSt	Measuring Offset	-1999 ÷ 9999	0
17	rot	Rotation of the measuring straight line	0.000 ÷ 2.000	1.000
18	InE	"OPE" functioning in case of measuring error	Our / Or / Ur	OUr
19	OPE	Output power in case of measuring error	-100 ÷ 100 %	0

Group "Out" (parameters relative to the outputs)

Par.	Description	Range	Def.	Note
20	O1F	Functioning of output 1	1.rEG / 2.rEG ALno / ALnc OFF	1.rEG
21	O2F	Functioning of output 2	1.rEG / 2.rEG ALno / ALnc OFF	ALno
22	O3F	Functioning of output 3	1.rEG / 2.rEG ALno / ALnc OFF	ALno
23	O4F	Functioning of output 4	1.rEG / 2.rEG ALno / ALnc OFF	ALno

Group "AL1" (parameters relative to alarm AL1)

Par.	Description	Range	Def.	Note
24	OAL1	Output where alarm AL1 is addressed	Out1 / Out2 Out3 / Out4 OFF	Out2
25	AL1t	Alarm AL1 type	LoAb / HiAb LHAb / LodE HidE / LHdE	LoAb
26	Ab1	Alarm AL1 functioning	0 ÷ 15	0
27	AL1	Alarm AL1 threshold	AL1L ÷ AL1H	0
28	AL1L	Low threshold band alarm AL1 or Minimum set alarm AL1 for high or low alarm	-1999 ÷ AL1H	-1999

29	AL1H	High threshold band alarm AL1 or Maximum set alarm AL1 for high or low alarm	AL1L ÷ 9999	9999	
30	HAL1	Alarm AL1 hysteresis	OFF ÷ 9999	1	
31	AL1d	Activation delay of alarm AL1	OFF ÷ 9999 sec.	OFF	
32	AL1i	Alarm AL1 activation in case of measuring error	no / yES	no	

Group "AL2" (parameters relative to alarm AL2)

Par.	Description	Range	Def.	Note
33	OAL2	Output where alarm AL2 is addressed	Out1 / Out2 Out3 / Out4 OFF	OFF
34	AL2t	Alarm AL2 type	LoAb / HiAb LHAb / LodE HidE / LHdE	LoAb
35	Ab2	Alarm AL2 functioning	0 ÷ 15	0
36	AL2	Alarm AL2 threshold	AL2L ÷ AL2H	0
37	AL2L	Low threshold band alarm AL2 or Minimum set alarm AL2 for high or low alarm	-1999 ÷ AL2H	-1999
38	AL2H	High threshold band alarm AL2 or Maximum set alarm AL2 for high or low alarm	AL2L ÷ 9999	9999
39	HAL2	Alarm AL2 hysteresis	OFF ÷ 9999	1
40	AL2d	Activation delay of alarm AL2	OFF ÷ 9999 sec.	OFF
41	AL2i	Alarm AL2 activation in case of measuring error	no / yES	no

Group "AL3" (parameters relative to alarm AL3)

Par.	Description	Range	Def.	Note
42	OAL3	Output where alarm AL3 is addressed	Out1 / Out2 Out3 / Out4 OFF	OFF
43	AL3t	Alarm AL3 type	LoAb / HiAb LHAb / LodE HidE / LHdE	LoAb
44	Ab3	Alarm AL3 functioning	0 ÷ 15	0
45	AL3	Alarm AL3 threshold	AL3L ÷ AL3H	0
46	AL3L	Low threshold band alarm AL3 or Minimum set alarm AL3 for high or low alarm	-1999 ÷ AL3H	-1999
47	AL3H	High threshold band alarm AL3 or Maximum set alarm AL3 for high or low alarm	AL3L ÷ 9999	9999
48	HAL3	Alarm AL3 hysteresis	OFF ÷ 9999	1
49	AL3d	Activation delay of alarm AL3	OFF ÷ 9999 sec.	OFF
50	AL3i	Alarm AL3 activation in case of measuring error	no / yES	no

Group "LbA" (parameters relative to Loop Break Alarm)

Par.	Description	Range	Def.	Note
51	OLbA	Output where alarm LbA is addressed	Out1 / Out2 Out3 / Out4 OFF	OFF
52	LbAt	Time necessary to activate alarm LbA	OFF ÷ 9999 sec.	OFF

Group "Hb" (parameters relative to Heater Break Alarm)

Par.	Description	Range	Def.	Note
53	OHb	Output where alarm HB is addressed	Out1 / Out2 Out3 / Out4 OFF	OFF
54	IFS	High scale limit for input TA HB	0.0 ÷ 100.0	100.0

55	HbF	Alarm HB function	1 / 2 / 3 / 4	1	
56	IHbL	Low alarm HB threshold (with Out 1rEG ON)	0.0 ÷ IFS	0.0	
57	IHbH	High alarm HB threshold (with Out 1rEG OFF)	IHbL ÷ IFS	100.0	

Group "rEG" (parameters relative to the control)

Par.	Description	Range	Def.	Note
58	Cont	Control type	Pid / On.FA On.FS / nr	Pid
59	Func	Functioning mode output 1rEg	HEAt / Cool	HEAt
60	HSEt	Hysteresis of ON/OFF control	0 ÷ 9999	1
61	Auto	Autotuning Fast enable	OFF / 1 / 2 / 3 / 4	1
62	SELF	Selftuning enable	no / yES	no
63	Pb	Proportional band	0 ÷ 9999	50
64	Int	Integral time	OFF ÷ 9999 sec.	200
65	dEr	Derivative time	OFF ÷ 9999 sec.	50
66	FuOc	Fuzzy overshoot control	0.00 ÷ 2.00	0,5
67	tcr1	Cycle time of output 1rEg	0.1 ÷ 130.0 sec.	20,0
68	Prat	Power ratio 2rEg / 1rEg	0.01 ÷ 99.99	1.00
69	tcr2	Cycle time of 2rEg	0.1 ÷ 130.0 sec.	10.0
70	rS	Manual reset	-100.0÷100.0 %	0.0
71	SLor	Gradient of rise ramp	0.00 ÷ 99.99 / InF unit/min.	InF
72	dur.t	Duration time	0.00 ÷ 99.99 / InF hrs.-min.	InF
73	SLoF	Gradient of fall ramp	0.00 ÷ 99.99 / InF unit / min.	InF
74	St.P	Soft-Start power	OFF / -100 ÷ 100 %	OFF
75	SSt	Soft-Start time	OFF / 0.1÷7.59 / InF hrs.-min.	OFF

Group "Pan" (parameters relative to the user interface)

Par.	Description	Range	Def.	Note
76	USrb	Functioning of key "F"	noF / tunE / OPLO / Aac / ASi / CHSP / OFF	noF
77	diSP	Variable visualized on the display	dEF / Pou / SP.F / SP.o / AL1 / AL2 / AL3	dEF
78	AdE	Shift value for the shift index functioning	OFF...9999	2
79	Edit	Fast programming of active Set Point and alarms	SE / AE / SAE / SAnE	SAE

Group "SEr" (parameters relative to the serial communication)

Par.	Description	Range	Def.	Note
80	Add	Station address in case of serial communication	0 ... 255	1
81	baud	Transmission speed (Baud rate)	1200 / 2400 / 9600 / 19.2 / 38.4	9600
82	PACS	Access at the programming through serial port	LoCL / LorE	LorE

5.2 - PARAMETERS DESCRIPTION

GROUP "1SP" (PARAMETERS RELATIVE TO THE SET POINT):
These allow the setting of the control Sets and the Sets function modes.

nSP – NUMBER OF PROGRAMMABLE SET POINTS: This allows definition of the number of Set Points which will be programmed and stored (from 1 to 4).

SPAt – ACTIVE SET POINT : If more than one Set Point is stored, this allows selection of the active Set Point.

SP1 - SET POINT 1: Value of the Set Point n. 1

SP2 - SET POINT 2: Value of the Set Point n. 2 (it appears if "nSP" >2 only)

SP3 - SET POINT 3: Value of the Set Point n. 3 (it appears if "nSP" >3 only)

SP4 - SET POINT 4: Value of the Set Point n. 4 (it appears if "nSP" =4 only)

SPLL – LOW SET POINT: Lower value programmable as Set Point

SPHL – HIGH SET POINT : Higher value programmable as Set Point

GROUP "1InP" (PARAMETERS RELATIVE TO THE INPUTS):

These permit the definition of visualization modes of the variable measured by the probe.

HCFG – INPUT TYPE : This permits selection of the input type : thermocouples (tc), thermo-resistances or thermistors (rtd), normalized signals in current (I), in voltage (UoLt) or a measurement coming from the serial line (SEr).

SEnS – PROBE TYPE: Depending on what is programmed on par.

"HCFG" this permits the type of probe to be selected :

- thermocouples ("HCFG"=tc): J (J), K (CrAL), S (S) or OSAKA infrared sensors IRTC1 series with J (Ir.J) or K (Ir.CA) linearization.

- thermoresistances/thermistors ("HCFG"=rtd): Pt100 IEC (Pt1) or thermistors PTC KTY81-121 (Ptc) or NTC 103AT-2 (ntc)

- normalized signals in current ("HCFG"=I): 0..20 mA (0.20) or 4..20 mA (4.20)

- normalized signals in voltage ("HCFG"=UoLt): 0..50 mV (0.50), 0..60 mV (0.60), 12..60 mV (12.60), 0..5 V (0.5), 1..5 V (1.5), 0..10 V (0.10) or 2..10 V (2.10).

SSC – LOW SCALE LIMIT IN EVENT OF INPUT WITH V/I SIGNALS : This is the value the instrument has to visualise when the minimum value that can be measured on the scale (0/4 mA, 0/12 mV, 0/1 V or 0/2 V) is present at the output.

FSC – HIGH SCALE LIMIT IN EVENT OF INPUT WITH V/I SIGNALS : This is the value the instrument has to visualise when the maximum value that can be measured on the scale (20 mA, 50 mV, 60 mV, 5 V or 10 V) is present at the input.

dP – NUMBER OF DECIMAL FIGURES: This allows determination of the measuring resolution as 1 (0), 0.1 (1), 0.01 (2), 0.001 (3). In the case of temperature probes the allowed resolutions are 1° (0) and 0.1° (1).

Unit – TEMPERATURE UNIT OF MEASUREMENT : When the temperature is measured by temperature probes, this parameter permits definition if the visualisation is expressed as degree Centigrade (°C) or Fahrenheit (°F).

Filt – INPUT DIGITAL FILTER : This permits programming of the constant of time of the software filter referring to the measured input value (in sec.) in order to reduce noise sensitivity (increasing the time of reading).

OFSt – MEASURING OFFSET: Positive or negative Offset which is added to the value measured by the probe.

rot – ROTATION OF THE MEASURING STRAIGHT LINE: In this way the offset programmed on par. "OFSt" is not constant for all measurements. By programming "rot"=1.000, the value "OFSt" is simply added to the value read by the probe before visualisation and it remains constant for all the measurements. If instead one does not want the programmed offset to be constant for all the measurements, it is possible to carry out calibration on two desired values.

In this case, to define the values to be programmed on par. "OFSt" and "rot", it is necessary to enforce the following formulae :

$$\text{"rot"} = (D2-D1) / (M2-M1) \quad \text{"OFSt"} = D2 - (\text{"rot"} \times M2)$$

where: M1 =measured value 1; D1 = visualisation value when the instrument measures M1

M2 =measured value. 2; D2 = visualisation value when the instrument measures M2

It then follows that the instrument will visualise : $DV = MV \times \text{"rot"} + \text{"OFSt"}$

where: DV = visualised value; MV= measured value

InE – "OPE" FUNCTIONING IN CASE OF MEASUREMENT ERROR: This defines the error conditions of the input allowing the instrument to give the power programmed on par. "OPE" as output. The possibilities are :

= Or : the condition occurs in case of over-range or probe breakage
= Ur : the condition occurs in case of under-range or probe breakage

= Our : the condition occurs in case of over-range or under-range or probe breakage

OPE – OUTPUT POWER IN CASE OF MEASUREMENT ERROR: This permits setting of the power that the instrument has to give as output in case of measurement error. For the ON/OFF regulators the power is calculated considering a cycle time equal to 20 sec.

GROUP "1 Out" (PARAMETERS RELATIVE TO THE OUTPUTS): They permit to program the outputs functioning.

O1F – FUNCTIONING OF OUTPUT OUT 1: This defines the functioning of output OUT 1 as: control output 1 (1.rEG), control output 2 (2.rEG), alarm output as normally open (ALno), output alarm normally closed (ALnc), output not used (OFF).

O2F - FUNCTIONING OF OUTPUT OUT 2: Similar to "O1F" but referring to output OUT2.

O3F - FUNCTIONING OF OUTPUT OUT 3: Similar to "O1F" but referring to output OUT3.

O4F - FUNCTIONING OF OUTPUT OUT 4: Similar to "O1F" but referring to output OUT4.

GROUP "1AL1" (PARAMETERS RELATIVE TO ALARM AL1): These permit setting of the process alarm AL1 function.

OAL1 – OUTPUT WHERE ALARM AL1 IS ADDRESSED: It defines to which output the alarm AL1 has to be addressed.

AL1t – ALARM AL1 TYPE: permits the choice of behaviour for alarm A1, by 6 different selections:

= LoAb – ABSOLUTE LOW ALARM : The alarm is activated when the process value goes below the alarm threshold set on parameter "AL1".

= HiAb - ABSOLUTE HIGH ALARM: The alarm is activated when the process value goes above the alarm threshold set on parameter "AL1".

= LHAb - ABSOLUTE BAND ALARM: The alarm is activated when the process value goes below the alarm threshold set on parameter "AL1L" or goes higher than alarm set on parameter "AL1H".

= LoDE – DEVIATION LOW ALARM: The alarm is activated when the process value goes below the value [SP + AL1]

= HiDE – DEVIATION HIGH ALARM: The alarm is activated when the process value goes above the value [SP + AL1]

= LHdE – DEVIATION BAND ALARM: The alarm is activated when the process value goes below the value [SP + AL1L] or goes above the value [SP + AL1H]

Ab1 – ALARM AL1 FUNCTION: This permits definition of alarm AL1 functions, by entering a number between 0 and 15. The number to be programmed, that corresponds to the desired function, is obtained adding the values reported in the following description :

ALARM BEHAVIOUR AT SWITCH ON:

+0 = NORMAL BEHAVIOUR: The alarm is always activated when there are alarm conditions.

+1 = ALARM NOT ACTIVATED AT SWITCH ON: If, at switch on, the instrument is in alarm condition, the alarm is not activated. It will be activated only when the process value goes beyond and then returns to alarm conditions.

ALARM DELAY:

+0 = ALARM NOT DELAYED: The alarm is immediately activated when the alarm condition occurs.

+2 = ALARM DELAYED: When the alarm condition occurs, delay counting starts as programmed on par. "ALnd" (expressed in sec.) and the alarm will be activated only after this time has elapsed.

ALARM LATCH:

+ 0 = ALARM NOT LATCHED: The alarm remains active in alarm conditions only.

+ 4 = ALARM LATCHED: The alarm is active in alarm conditions and remains active even if these conditions no longer exist, until the correctly programmed key "F" ("USrb"=Aac) has been pushed

ALARM AKNOWLEDGEMENT:

+ 0 = ALARM NOT AKNOWLEDGED: The alarm remains always active in alarm conditions.

+ 8 = ALARM AKNOWLEDGED: The alarm is active in alarm conditions and can be deactivated through key "F" if properly programmed ("USrb"=Asi), also if alarm conditions still exist.

AL1 – ALARM AL1 THRESHOLD : Alarm AL1 threshold for low and high alarms.

AL1L – LOW ALARM AL1 : Alarm AL1 low threshold when the alarm is a band type or minimum set of AL1 alarm threshold when the alarm is low or high type.

AL1H – HIGH ALARM AL1: Alarm AL1 high threshold when the alarm is a band type or maximum set of AL1 alarm threshold when the alarm is low or high type.

HAL1 - ALARM AL1 HYSTERESIS: Asymmetrical semi-band relative to alarm AL1 threshold which defines the deactivation value of alarm AL1.

AL1d – ACTIVATION DELAY OF ALARM AL1: This permits definition of alarm delay activation AL1 when the delay function on par. "Ab1" is activated.

AL1i – ALARM AL1 ACTIVATION IN CASE OF MEASUREMENT ERROR: This permits a definition of measurement error conditions, i.e whether the alarm has to be active ("YES") or not ("no").

GROUP "1AL2" (PARAMETERS RELATIVE TO ALARM AL2): These permit the setting of the process alarm AL2 functions.

OAL2 - OUTPUT WHERE ALARM AL2 IS ADDRESSED: this defines on which output the alarm AL2 has to be addressed.

AL2t - ALARM AL2 TYPE: Similar to "AL1t" but referring to alarm AL2.

Ab2 - ALARM AL2 FUNCTIONING: Similar to "Ab1t" but referring to alarm AL2.

AL2 - ALARM AL2 THRESHOLD : Similar to "AL1" but referring to alarm AL2.

AL2L - LOW ALARM AL2 : Similar to "AL1L" but referring to alarm AL2.

AL2H - HIGH ALARM AL2 : Similar to "AL1H" but referring to alarm AL2.

HAL2 - ALARM AL2 HYSTERESIS: Similar to "HAL1" but referring to alarm AL2.

AL2d - ACTIVATION DELAY OF ALARM AL2: Similar to "AL1d" but referring to alarm AL2.

AL2i - ALARM AL2 ACTIVATION IN CASE OF MEASUREMENT ERROR: Similar to "AL1i" but referring to alarm AL2.

GROUP "1AL3" (PARAMETERS RELATIVE TO ALARM AL3): These permit the setting of the process alarm AL3.

OAL3 - OUTPUT WHERE ALARM AL3 IS ADDRESSED: It defines on which output the alarm AL3 has to be addressed.

AL3t - ALARM AL3 TYPE: Similar to "AL1t" but referring to alarm AL3.

Ab3 - ALARM AL3 FUNCTIONING: Similar to "Ab1t" but referring to alarm AL3.

AL3- ALARM AL3 THRESHOLD : Similar to "AL1" but referring to alarm AL3.

AL3L - LOW ALARM AL3 : Similar to "AL1L" but referring to alarm AL3.

AL3H - HIGH ALARM AL3 : Similar to "AL1H" but referring to alarm AL3.

HAL3 - ALARM AL3 HYSTERESIS: Similar to "HAL1" but referring to alarm AL3.

AL3d - ACTIVATION DELAY OF ALARM AL3: Similar to "AL1d" but referring to alarm AL3.

AL3i - ALARM AL3 ACTIVATION IN CASE OF MEASUREMENT ERROR: Similar to "AL1i" but referring to alarm AL3.

GROUP "LbA" (PARAMETERS RELATIVE TO THE LOOP BREAK ALARM): this contains the parameters relative to the Loop Break alarm (control loop interruption), which intervenes when, for any reason (short-circuit of a thermocouple, load interruption, etc) the control loop is interrupted.

OLbA – OUTPUT WHERE THE LOOP BREAK ALARM IS ADDRESSED: This defines to which output the LOOP BREAK alarm has to be addressed.

LbAt – TIME NECESSARY TO ACTIVATE THE LOOP BREAK ALARM : Delay time to the intervention of the Loop Break alarm. The alarm intervenes when the output power remains at 100% for the time programmed on this parameter (in sec.)

GROUP "IHb" (PARAMETERS RELATIVE TO THE HEATER BREAK ALARM): this contains the parameters relative to the Heater Break alarm (heating element breakage).

This function is present only when the instrument is equipped with the input (TAHB) to measure the current absorbed by the load. This input accepts signals coming from current transformers (TA) with max. output 50 mA.

OHb – OUTPUT WHERE HEATER BREAK ALARM IS ADDRESSED: this defines to which output the HEATER BREAK alarm has to be addressed.

IFS – HIGH SCALE LIMIT FOR INPUT TA HB: Value that the instrument has to visualise when as input TA HB It is present a value of 50 mA.

HbF – ALARM HB FUNCTION: It defines the functioning of the Heater Break alarm as:

= 1 : The alarm is active when, with output 1rEG active, the current measured by the input TAHB is lower than the value programmed on par. "IHbL".

= 2 : The alarm is active when, with output 1rEG not active, the current measured by the input TAHB is higher than the value programmed on par. "IHbH".

= 3 : The alarm is active when, with output 1rEG active, the current measured by the input TAHB is lower than the value programmed on par. "IHbL" or with output 1rEG not active, the current measured by the input TAHB is higher than the value programmed on par. "IHbH".

= 4 : The alarm is active when the current measured by the input TAHB is lower than the value programmed on par. "IHbL" or the measured current is higher than the value programmed on par. "IHbH", independently by the state of the output 1rEG.

IHbL – LOW ALARM HB THRESHOLD: Enter the value of the current normally absorbed by the load driven by the output 1rEG, when this is active.

IHbH – HIGH ALARM HB THRESHOLD: Enter the value of the current normally absorbed by the load driven by the output 1rEG, when this is not active.

GROUP "1rEG" (PARAMETERS RELATIVE TO THE CONTROL): this contains the parameters relative to control functions.

Cont – CONTROL TYPE: This permits selection of one of the possible control modes offered by the instrument : PID (Pid), ON/OFF with asymmetrical hysteresis (On.FA), ON/OFF with symmetrical hysteresis (On.FS), Neutral Zone ON/OFF (nr).

Func – FUNCTIONING MODE OUTPUT 1rEG: this permits one to decide whether the control output 1rEG has to carry out a reverse action, as for example a Heating process ("HEAT") or a direct action, as for example a Cooling process ("Cool").

HSEt –ON/OFF CONTROL HYSTERESIS: Semi-band relative to the Set Point which defines the activation and deactivation values of the control output/s in case of ON/OFF control (On.FA, On.FS, nr).

Auto – AUTO-TUNING FAST ENABLE : this parameter allows one to decide how Auto-tuning has to be carried out. The possible selections are :

= 1 – if auto-tuning is desired automatically, each time the instrument is switched on, on the condition that the process value is lower (with "Func" =HEAT) than [SP- |SP/2|] or higher (with "Func" =Cool) than [SP+ |SP/2|].

= 2 – if auto-tuning is desired automatically, the next time the instrument is switched on, on the condition that the process value is lower (with "Func" =HEAT) than [SP- |SP/2|] or higher (with "Func" =Cool) than [SP+ |SP/2|], and once the tuning is finished, the par. "Auto" is automatically swapped to the OFF state

= 3 - if manual auto-tuning is desired, by selecting par. "tunE" in the main menu or by correctly programming key "F" as "USrb" = tunE. In this case the auto-tuning starts without any control on the process value condition. It is recommended to use this option, starting the auto-tuning when the process value is as far as possible from the Set Point because, in order to feature the Auto-tuning FAST with its best performances , it is preferable to respect this condition.

= 4 - if it's desired to activate the autotuning automatically at the end of programmed Soft-Start cycle. The Autotuning will start at the condition that the process value is lower (with "Func" =HEAT) than [SP- |SP/2|] or higher (with "Func" =Cool) than [SP+ |SP/2|].

= OFF - Autotuning disabled.

When it's occurring an Autotuning cycle, led AT blinks.

SELF – SELF-TUNING ENABLE: Parameter used to enable (yES) or disable (no) the Self-tuning function. Once the function has been enabled, the Self-tuning has to be started by selecting item "tunE", in the main menu, or through key F properly programmed ("USrb" = tunE).When the Self-tuning function is active, led AT is permanently lit, and all the PID parameters ("Pb", "Int", "dEr", ecc.) are no longer visualised.

Pb – PROPORTIONAL BAND: Width of the band around the Set Point within which the proportional control is performed.

Int – INTEGRAL TIME: Integral time to be programmed in the PID algorithm, expressed in sec.

dEr – DERIVATIVE TIME: : Derivative time to be programmed in the PID algorithm, expressed in sec.

FuOc - FUZZY OVERSHOOT CONTROL: Parameter that permits the elimination of the variable over-shoots at the start up of the process or at the changing of the Set Point. A low value of this parameter reduces the overshoot while a high value increase it.

tcr1 – CYCLE TIME OF OUTPUT 1rEG : Cycle time of output 1rEG with PID control mode, expressed in sec..

Prat – POWER RATIO 2rEG / 1rEG : Parameter where it is possible to program the power ratio between the element controlled by output 2rEG (ex.Cooling) and the element controlled by output 1rEG (ex. Heating) in case of PID double action control.

tcr2 - CYCLE TIME OF OUTPUT 2rEG : Cycle time of output 2rEG with PID double action control mode, expressed in sec..

rS - MANUAL RESET: Power Offset added to the power increase of the proportional term, in order to eliminate the error when it is not present the integral value. This parameter is only visualised when "Int" =0.

Parameters relative to the ramps, allowing the Set Point to be reached in a predetermined time.

Furthermore, once the first Set (SP1) has been reached, it is possible to have automatic switching to the second Set (SP2) after a programmable time, thus obtaining a simple thermal cycle (functions available for all the control types)

SLor – GRADIENT OF RISE RAMP: Gradient of rise ramp to be carried out when the process value is lower than the active Set Point, expressed in unit/minute.

Programming the parameter = InF the ramp is not active.

dur.t - DWELL TIME: Dwell time of the Set Point SP1 before the automatic switching to SP2 (expressed in hrs. and min.)

Using this parameter, once the first Set (SP1) has been reached, it is possible to have automatic switching to the second Set (SP2) after a programmable time, thus obtaining a simple thermal cycle.

Programming the parameter = InF the function is not active.

SLoF - GRADIENT OF FALL RAMP: Gradient of fall ramp to be carried out when the process value is higher than the active Set Point, expressed in unit/minute.

Programming the parameter = InF the ramp is not active.

Parameters relative to the Soft-Start function, which allows limitation of control power, when the instrument is switched on, for a predetermined time. This function is only available for PID control.

St.P - SOFT START POWER: If parameter "SSt" is programmed with a value other than OFF, this is the power given as output at the instrument switch on, for the time "SSt".

Practically speaking, the instrument works in manual condition and switches to automatic control at the elapsing of time "SSt".

If instead par. "St.P" = OFF and a value is set on par. "SSt" at switch on, the power calculated by the PID controller is divided by the time "SSt", in order to calculate a ramp. The output power starts from 0 and is progressively increased, according to the calculated ramp, until the time "SSt" is reached or until the power overcomes the power calculated by the PID controller.

SSt - SOFT START TIME (for PID control only): Duration time in hours and min. of the Soft-Start described on pa. "St.P".

To disable the Soft-Start function set par. "SSt" = OFF.

GROUP "Pan" (PARAMETERS RELATIVE TO THE USER INTERFACE): This contains the parameters relative to the key F and display functions.

Urb - KEY F FUNCTION: Decides which function is associated to key F. The possible selections are:

= noF : no function

= tunE : Pushing the key for 1 sec. at least, it is possible to activate/deactivate the Auto-tuning or the Self-tuning

= OPLO : Pushing the key for 1 sec. at least, it is possible to swap from the automatic control (rEG) to the manual one (OPLO) and vice versa.

= Aac : Pushing the key for 1 sec. at least, it is possible to acknowledge the alarm.

= ASi : Pushing the key for 1 sec. at least, it is possible to acknowledge an active alarm

= CHSp : Pushing the key for 1 sec. at least, it is possible to select one of the 4 pre-programmed Set Points on rotation.

= OFF : Pushing the key for 1 sec. at least, it is possible to swap from the automatic control (rEG) to the OFF control (OFF) and vice versa.

diSP - VARIABLE VISUALISED ON THE DISPLAY: Parameter through which it is possible to decide what is visualised on the display: the process variable (= dEF), the control power (= Pou), the active Set Point (= SP.F), the Set Point active when there are ramps (= SP.o) or the alarm thresholds AL1, 2 or 3 (= AL1, AL2 or AL3).

AdE - SHIFT VALUE FOR THE SHIFT INDEX FUNCTIONING: This allows one to decide the functioning mode of the 3 led shift indexes.

The lighting of the green led "=" indicates that the process value is within the range [SP+AdE ... SP-AdE], the lighting of the red led "-" indicates that the process value is lower than the value [SP-AdE] and the lighting of the red led "+" indicates that the process value is higher than the value [SP+AdE].

Edit - FAST PROGRAMMING OF ACTIVE SET POINT AND ALARMS: This decides which are the Sets that can be programmed by the fast procedure. The parameter can be programmed as:

=SE: The active Set Point can be modified while the alarm thresholds cannot be modified

=AE: The active Set Point cannot be modified while the alarm thresholds can be modified

=SAE: If the active Set Point or the alarm thresholds can be modified

=SAnE: If the active Set Point or the alarm thresholds cannot be modified

GROUP "Ser" (PARAMETERS RELATIVE TO THE SERIAL COMMUNICATION): If the instrument is equipped with RS485 serial communication these parameters allow device configuration for communication.

Add - STATION ADDRESS IN CASE OF SERIAL COMMUNICATION: This is used to set the instrument address in the communication net. Programme a different number for each station, from 1 to 255.

baud - TRANSMISSION SPEED (BAUD RATE): Set the data transmission speed of the network to which the instrument is connected. The possible selections are 1200, 2400, 9600, 19.2 (19200), 38.4 (38400).

All stations must have the same transmission speed.

PACS ACCESS TO PROGRAMMING THROUGH SERIAL PORT: Programming access. If programmed as "LoCL" this means that the instrument can only be programmed from the keyboard, if programmed as "LorE" it can be programmed from both the keyboards and serial line.

6 - PROBLEMS, MAINTENANCE AND GUARANTEE

6.1 - ERROR SIGNALLING

Error	Reason	Action
----	Probe interrupted	Verify the correct connection between probe and instrument and then verify the correct functioning of the probe
uuuu	The measured variable is under the probe's limits (under-range)	
oooo	The measured variable is over the probe's limits (over-range)	
ErAt	Auto-tuning not possible because the process value is higher (with "Func" =HEAT) than [SP- SP/2] or lower (with "Func" =Cool) than [SP+ SP/2].	Swap the instrument to OFF control (OFF) and then to automatic control (rEG) in order to make the error message disappear. Once the error has been found, try to repeat the auto-tuning.
noAt	Auto-tuning not finished within 12 hours	Check the functioning of probe and actuator and try to repeat the auto-tuning.
LbA	Loop control interrupted (Loop break alarm)	Check the working of probe and actuator and swap the instrument to (rEG) control
ErEP	Possible anomaly of the EEPROM memory	Push key "Set"

In error conditions, the instrument provides an output power as programmed on par "OPE" and activates the desired alarms, if the relative parameters "ALn" have been programmed = yES.

6.2 - CLEANING

We recommend cleaning of the instrument with a slightly wet cloth using water and not abrasive cleaners or solvents which may damage the instrument.

6.3 - GUARANTEE AND REPAIRS

The instrument is under warranty against manufacturing flaws or faulty material, that are found within 12 months from delivery date.

The guarantee is limited to repairs or to the replacement of the instrument.

The eventual opening of the housing, the violation of the instrument or the improper use and installation of the product will bring about the immediate withdrawal of the warranty's effects.

In the event of a faulty instrument, either within the period of warranty, or further to its expiry, please contact our sales department to obtain authorisation for sending the instrument to our company.

The faulty product must be shipped to OSAKA with a detailed description of the faults found, without any fees or charge for OSAKA, except in the event of alternative agreements.

7 - TECHNICAL DATA

7.1 – ELECTRICAL DATA

Power supply: 24 VAC/VDC, 100... 240 VAC +/- 10%

Frequency AC: 50/60 Hz

Power consumption: 9 VA approx.

Input/s: 1 input for temperature probes: tc J,K,S ; infrared sensors OSAKA IRS J e K; RTD Pt 100 IEC; PTC KTY 81-121 (990 Ω @ 25 °C); NTC 103AT-2 (10KΩ @ 25 °C) or mV signals 0...50 mV, 0...60 mV, 12 ...60 mV or normalized signals 0/4...20 mA, 0/1...5 V , 0/2...10 V.

1 input for current transformer (50 mA max.)

Normalized signals input impedance: 0/4..20 mA: 51 Ω; mV and V: 1 MΩ

Output/s: Up to 4 outputs. Relay SPST-NO (OUT1:5 A-AC1, 2 A-AC3 / 250 VAC; OUT2-3-4: 3 A-AC1, 1 A-AC3 / 250 VAC) ; or in tension to drive SSR (7mA/ 14VDC) ; the output OUT1 for SSR can be 20mA/14VDC if the 12 VDC auxiliary supply output is not used.

Auxiliary supply output: 12 VDC / 20 mA Max.

Electrical life for relay outputs: 100000 operat.

Installation category: II

Measurement category: I

Protection class against electric shock: Class II for Front panel

Insulation: Reinforced insulation between the low voltage section (supply and relay outputs) and the front panel; Reinforced insulation between the low voltage section (supply and relay outputs) and the extra low voltage section (inputs, SSR outputs); SSR outputs optoisolated respect to the input. 50 V insulation between RS485 and extra low voltage section.

7.2 – MECHANICAL DATA

Housing: Self-extinguishing plastic, UL 94 V0

Dimensions: 48 x 48 mm DIN, depth 98 mm

Weight: 190 g approx.

Mounting: Flush in panel in 45 x 45 mm hole

Connections: 2 x 1 mm² screw terminals block

Degree of front panel protection : IP 54 mounted in panel with gasket

Pollution situation: 2

Operating temperature: 0 ... 50 °C

Operating humidity: 30 ... 95 RH% without condensation

Storage temperature: -10 ... +60 °C

7.3 – MECHANICAL DIMENSIONS, PANEL CUT-OUT AND MOUNTING [mm]

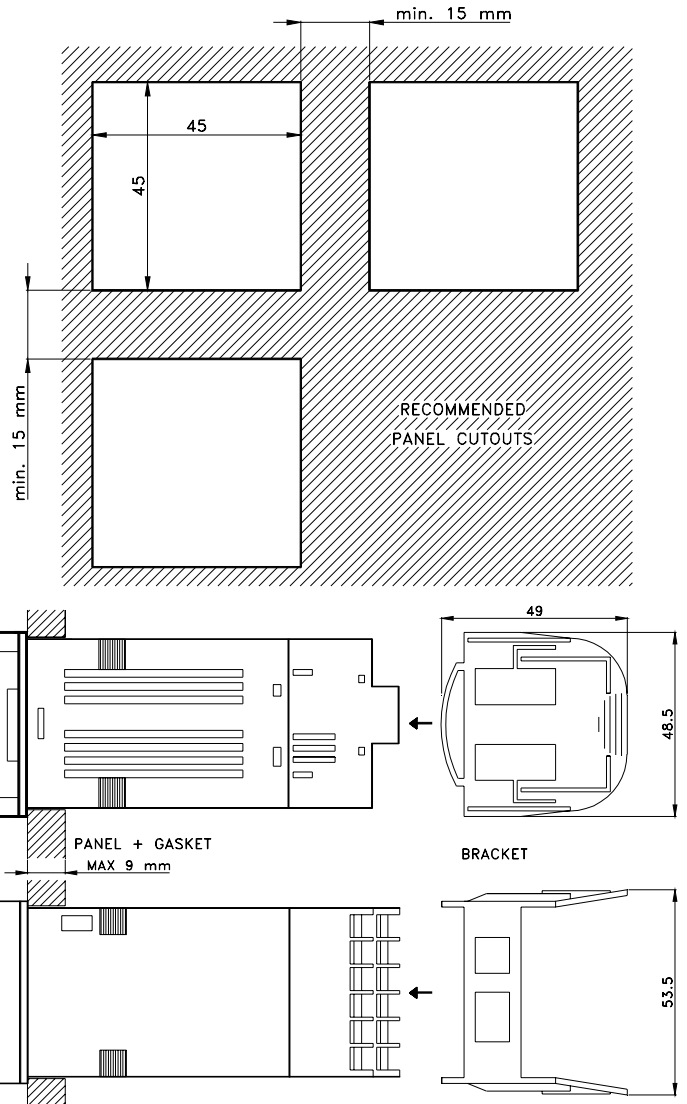
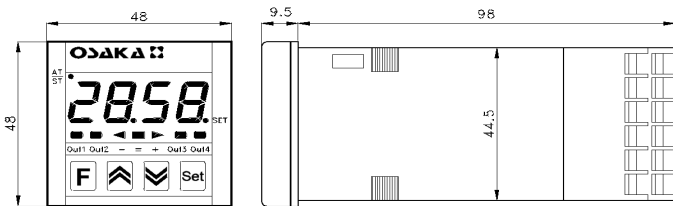

7.4 – FUNCTIONAL FEATURES

Control: ON/OFF, single and double action PID

Measurement range: according to the used probe (see range table)

Display resolution: according to the probe used 1/0,1/0,01/0,001

Overall accuracy: +/- 0,15 % fs

Max cold junction compensation drift (input tc) : 0,04 °C/°C with operating temperature 0 ... 50 °C after warm-up of 20 min.

Sampling rate: 130 ms.

Serial Interface : RS485 insulated

Communication protocol: MODBUS RTU (JBUS)

Baud rate: Programmable from 1200 ... 38400 baud

Display: 4 Digit Red h 12 mm

Compliance: ECC directive EMC 89/336 (EN 61326), ECC directive LV 73/23 and 93/68 (EN 61010-1)

7.5 – MEASURING RANGE TABLE

INPUT	"dP" = 0	"dP" = 1, 2, 3
tc J "HCFG" = tc "SEnS" = J	-160 ... 1000 °C - 256 ... 1832 °F	-160.0 ... 999.9 °C -199.9 ... 999.9 °F
tc K "HCFG" = tc "SEnS" = CrAl	-270 ... 1370 °C - 454 ... 2498 °F	-199.9 ... 999.9 °C -199.9 ... 999.9 °F

tc S "HCFG" = tc "SEnS" = S	-50 ... 1760 °C -58 ... 3200 °F	-50.0 ... 999.9 °C -58.0 ... 999.9 °F
Pt100 (IEC) "HCFG" = rtd "SEnS" = Pt1	-200 ... 850 °C -328 ... 1562 °F	-199.9 ... 850.0 °C -199.9 ... 999.9 °F
PTC (KTY81-121) "HCFG" = rtd "SEnS" = Ptc	-55 ... 150 °C -67 ... 302 °F	-55.0 ... 150.0 °C -67.0 ... 302.0 °F
NTC (103-AT2) "HCFG" = rtd "SEnS" = ntc	-50 ... 110 °C -58 ... 230 °F	-50.0 ... 110.0 °C -58.0 ... 230.0 °F
0 ... 50 mV "HCFG" = UoLt "SEnS" = 0.50	-1999 ... 9999	-199.9 ... 999.9 -19.99 ... 99.99 -1.999 ... 9.999
0..20 mA "HCFG" = I "SEnS" = 0.20	-1999 ... 9999	-199.9 ... 999.9 -19.99 ... 99.99 -1.999 ... 9.999
4..20 mA "HCFG" = I "SEnS" = 4.20	-1999 ... 9999	-199.9 ... 999.9 -19.99 ... 99.99 -1.999 ... 9.999
0 ... 60 mV "HCFG" = UoLt "SEnS" = 0.60	-1999 ... 9999	-199.9 ... 999.9 -19.99 ... 99.99 -1.999 ... 9.999
12 ... 60 mV "HCFG" = UoLt "SEnS" = 12.60	-1999 ... 9999	-199.9 ... 999.9 -19.99 ... 99.99 -1.999 ... 9.999
0 ... 5 V "HCFG" = UoLt "SEnS" = 0.5	-1999 ... 9999	-199.9 ... 999.9 -19.99 ... 99.99 -1.999 ... 9.999
1 ... 5 V "HCFG" = UoLt "SEnS" = 1.5	-1999 ... 9999	-199.9 ... 999.9 -19.99 ... 99.99 -1.999 ... 9.999
0 ... 10 V "HCFG" = UoLt "SEnS" = 0.10	-1999 ... 9999	-199.9 ... 999.9 -19.99 ... 99.99 -1.999 ... 9.999
2 ... 10 V "HCFG" = UoLt "SEnS" = 2.10	-1999 ... 9999	-199.9 ... 999.9 -19.99 ... 99.99 -1.999 ... 9.999

f = COMMUNICATION INTERFACE

S = RS 485 Serial interface

- = No interface

g : CURRENT TRANSFORMER INPUT

- = Not present

H = Present

h : OPTIONAL PROBES

- = None

ii : SPECIAL CODES

OK 81 PASSWORD = 381

7.6 – INSTRUMENT ORDERING CODE

OK 81 a b c d e f g ii

a : POWER SUPPLY

L = 24 VAC/VDC

H = 100 ... 240 VAC

b : OUTPUT OUT1

R = Relay

O = VDC for SSR

c : OUTPUT OUT2

R = Relay

O = VDC for SSR

- = None

d : OUTPUT OUT3

R = Relay

O = VDC for SSR

- = None

e : OUTPUT OUT4 (it has to be of the same tipe as OUT3)

R = Relay

O = VDC for SSR

- = None