

CI 49

MICROPROCESSOR-BASED DIGITAL ELECTRONIC PULSE COUNTER



OPERATING INSTRUCTIONS

PREVIOUS STATEMENT

In this manual are contained all the necessary information for a correct installation and the instructions for the use and the maintenance of the product; we recommend, therefore, to read carefully the following instructions.

The maximum care has been used in the realisation of this document, anyway OSAKA does not assume any responsibility deriving from the use of itself.

The same consideration has to be done for each person or Company involved in the creation of this manual.

The herewith issue is an exclusive property of OSAKA which forbids any reproduction and divulgation, although partial, if not expressly authorised.

OSAKA reserves the right to execute aesthetically and functional modifications, at any moment and without any notice.

INDEX

- 1 INSTRUMENT DESCRIPTION**
- 1.1 GENERAL DESCRIPTION
- 1.2 FRONT PANEL DESCRIPTION
- 2 PROGRAMMING**
- 2.1 SET POINT PROGRAMMING
- 2.2 PARAMETERS PROGRAMMING
- 2.3 PARAMETERS LOCK
- 3 INSTALLATION AND USE ADVICES**
- 3.1 USE ALLOWED
- 3.2 MECHANICAL MOUNTING
- 3.3 ELECTRICAL CONNECTIONS
- 3.4 ELECTRICAL CONNECTION DRAWING
- 4 OPERATING MODE**
- 4.1 COMMANDS OPERATING MODE
- 4.2 DISPLAY OPERATING MODE
- 4.3 OUT 1 OPERATING MODE
- 4.4 OUT 2 OPERATING MODE
- 5 PROGRAMMABLE PARAMETERS**
- 5.1 PARAMETERS TABLE
- 5.2 PARAMETERS DESCRIPTION
- 6 TROUBLES, MAINTENANCE, WARRANTY**
- 6.1 CLEANING
- 6.2 WARRANTY AND REPAIRS
- 7 TECHNICAL DATA**

- 7.1 ELECTRICAL DATA
- 7.2 MECHANICAL DATA
- 7.3 MECHANICAL DIMENSIONS, PANEL CUT OUT AND FIXING DEVICE
- 7.4 FUNCTIONAL DATA
- 7.5 INSTRUMENT CODE

1 - INSTRUMENT DESCRIPTION

1.1 - GENERAL DESCRIPTION

CI 49 is a programmable microprocessor based counter with 1 or 2 outputs. The instrument offers the possibility to program: up to 2 set points, 3 operating modes for the output OUT1, 4 operating modes for the output OUT2, 2 counting mode (UP or DOWN) and offers the possibility of counting division. The counting state is visualised on 4 digits display while the outputs state is signalled by 2 led. The instrument can have 2 outputs (relay or to drive solid state relays) and 2 digital inputs, one for counting (CNT) and one programmable as RESET or reverse counting. The digital inputs signals can be for free voltage contacts or voltage signals (the same voltage supply value). The programming of the instrument is possible by means of the 3 keys placed on the front where is also a reset key (F)..

1.2 - FRONT PANEL DESCRIPTION



1 - Key Set : Used for the set point setting and to program the functioning parameters

2 - Key DOWN : Used to decrease the values or to select parameters

3 - Key UP : Used to increase the values or to select parameters

4 - Key F : Used to reset the count

5 - Led OUT 1 : It indicates when the output OUT1 is on or off.

6 - Led OUT 2 : It indicates when the output OUT2 is on or off.

7 - Led SET/CNT : Signalize the set point or the parameters programming mode (flashing fast), the count on (on) or reset mode (off).

2 - PROGRAMMING

2.1 - SET POINTS PROGRAMMING

The instrument permits to program up to 2 sets: "C1" and "C2".

To program this sets do proceed as follows :

Pushing Key Set and keeping it pushed for 1 sec. approx., the display will visualize "C1" and led SET/CNT will blink rapidly.

Releasing the key, on the display will be visualized the programmed Set Point "C1".

To modify it, work on keys UP, to increase the value or on key DOWN, to decrease it.

If the OUT2 programmed functioning mode require the set "C2" (F2 = 3 or 4), for programming this pressing Key Set again and the display will show "C2".

Releasing the key, on the display will be visualized the programmed Set Point "C2" and will be possible to modify it by the key UP or DOWN.

The outgoing from the set points programming it's automatically obtainable not working on any key for 5 sec. approx. or pressing only one time the key F, thus the counting value will again be displayed.

The programming of the sets is always possible, both with counting on or off.

2.2 - PARAMETERS PROGRAMMING

To have access at the functioning parameters, it's necessary to push Key Set and keep it pushed for 5 sec. approx.

After 4 sec. will appear the label of the first parameter ("F1"). Now it possible to release Key Set and it will appear the value programmed for parameter "F1".

To modify this value work on keys UP or DOWN.

Once the desired value has been programmed, pushing again Key Set the display will show the label of the successive parameter.

Releasing then key Set, it will appear the value programmed for that parameter which can be modified working on keys UP and DOWN.

Pushing and releasing Key Set it's possible to visualize all the parameters labels (when key is pushed) and the relative programming (when key is released) one after the other.

The outgoing from the parameters programming it's obtainable not working on any key for 20 sec. approx. or pressing only one time the key F, thus the counting value will again be displayed.

P.A.: During the counting is not possible to enter in the parameters programming mode.

2.3 - PARAMETERS LOCK

It's possible to lock the access at the programming parameters with the following procedure :

Switch off the instrument, push Key Set and keep it pushed while the instrument is switched on again.

After approx. 5 sec. on the display will appear "uL" (unlock) which indicates that the parameters are accessible.

Keeping pushed Key Set and pushing key DOWN it will appear "Lo"

(lock) which indicates that the parameters are not accessible.

Release Key Set to exit from this modality.

The display will go back to the normal functioning, the parameters will not be accessible anymore and it will only be possible to modify the Set Point.

To have again access at the parameters, repeat the same procedure pushing Key Set and selecting "uL" ; finally go out from the parameters lock modality.

3 - INSTALLATION AND USE ADVICES



3.1 - PERMITTED USE

The instrument has been projected as measure and control device, built according to EN61010-1 for the altitudes operation until 2000 ms.

The use of the instrument for applications not expressly allowed by the above mentioned rule has to foreseen proper protection devices.

The instrument CAN'T be used in environments with dangerous atmosphere (flammable or explosive) without a proper protection.

It has to be reminded that the user has to take care that the electromagnetic rules are being respected also after the instrument installing, eventually using proper filters.

Whenever a failure or a bad functioning of the instrument may cause dangerous situations or damage to people, things or animals it has to be reminded that the plant has to be equipped with additional electromechanical devices in order to grant the safety.

3.2 - MECHANICAL MOUNTING

The instrument, in DIN case 48 x 48 mm, is designed for flush-in panel mounting. Make a hole 45 x 45 mm and insert the instrument, fixing it with the provided special bracket. We recommend to mount the gasket to obtain the front protection degree as declared. Do avoid to place the instrument in ambient with very high humidity or dirt that may create condensation or introduction into the instrument of conductive substances. Ensure the adequate ventilation to the instrument and avoid the installation within boxes where are placed devices which may overheat or have as a consequence the instrument's functioning at higher temperature than allowed and declared. Connect the instrument as far as possible from source of electromagnetic disturbances so as motors, power relays, relays, electrovalves, etc. The instrument is removable from its housing by the front side : is recommended to disconnect the power supply from the instrument when it's necessary to effectuate this operation.

3.3 - ELECTRICAL CONNECTIONS

Carry out the electrical wiring connecting only one wire for each terminal, according to the following diagram, checking that the power supply is the same as indicated on the instrument and the loads current is not higher than the maximum current admitted. The instrument, being a built in equipment with permanent connection into a cabinet, is not equipped neither with switches nor with internal devices protecting from overcurrent : the installation shall employ a two-phase circuit-breaker, placed as near as possible to the instrument, located in a position easily reachable by the user and marked as instrument disconnecting device. It's recommended, furthermore, to properly protect all the electric circuits connected to the instrument, with devices (ex. fuses) proportionate to the circulating currents. It's strongly recommended to use cables with proper insulation, according to the working voltages and temperatures. Furthermore, the input cable of the probe has to be kept separate from line voltage wiring. If the input cable of the probe is screened, it has to be connected on the ground with only one side. Finally, it is advisable to check that the parameters are those desired before connecting the outputs to the actuators in order to avoid plant anomalies which may cause injuries to people, things or animals.

OSAKA and its legal representatives are not responsible for any eventual damages to people, things or animals deriving from the instrument violation, not proper or wrong use or in any case not in accordance with the instrument features.

3.4 - ELECTRICAL CONNECTION DRAWING

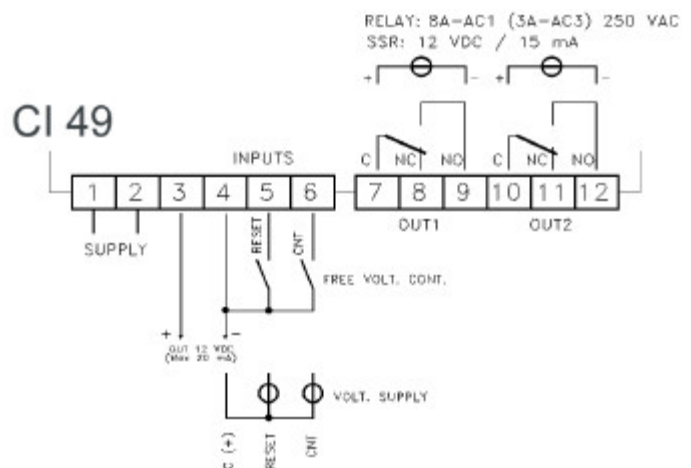

4- OPERATING MODE

4.1 – FUNCTIONING OF THE COUNTING COMMANDS

To the first pulse received by the CNT input the counter goes in counting mode that is signalled by the led SET/CNT.

Under this condition it is possible to visualize and to modify the set, but it is not possible to program the parameters.

To enter in the parameters programming mode is needed to reset the counter through the RESET input if par. "E"=1 or the key F if par. "t" = 1.

The reset of the display and of the output happens automatically when operation mode is "F1" = 1 (Restart) or "F1" = 2 (Restart-lap) or can be manual through the RESET input if par. "E"=1 or the key F if par. "t" = 1.

Through the parameter "E" it is possible to use the RESET input to operate as command of reverse counting.

When you program the par. "E" = 2 to the activation of the input the counting is reversed and therefore the acquired pulses are subtracted if counting mode is UP ("C"=1) or added if counting mode is DOWN ("C"=2).

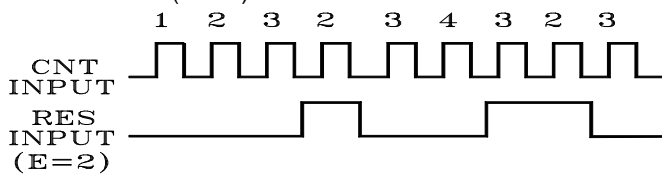

In this operation mode it is necessary to pay attention at counting speed because the Reset input have a delay of 15 msec. and therefore the inversion of the calculation is not instant.

For this reason the use of the function recommends only when the input frequency is low.

Using a contact that closes with advance in comparison to the other to which is connected is possible to realize, for instance, the following application of UP/DOWN counting.

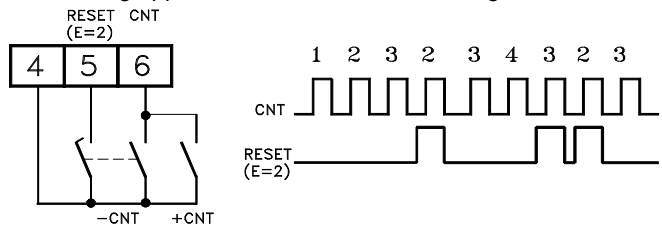

With this UP/DOWN counting applications the counting cannot assume negative values and therefore reached the value 0 (counting UP) or the set value (counting DOWN) others pulses can't be acquired.

In order of the model the counting signal can be from free voltage contacts, from devices with transistor output NPN (models with inputs C) or from voltage signals with the same voltage of the instrument supply (models with inputs V).

The instruments with inputs type C have besides an output (12 VDC) to supply the counting device (proximity, photocell or other) with transistor output NPN.

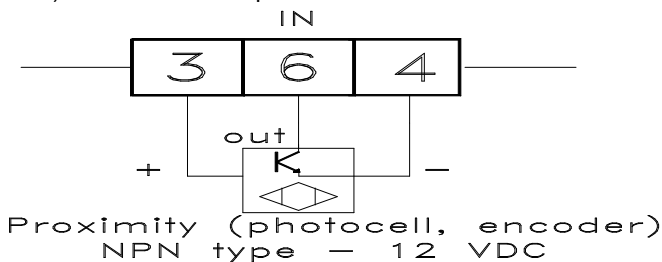

In order to the counting frequency is advisable to program the filter software of the par. "H" that it allows to select the

maximum counting frequency and to avoid false counting (for instance caused by the contacts rebounds).

Particularly for the instruments with inputs type V (voltage signals) it recommends to program the parameter "H" < 3 because the instrument could count the pulses produced by the main supply frequency.

4.2 – FUNCTIONING OF THE DISPLAY

The led SET/CNT is used to indicate the access into the programming (flashing), the counting in action (on) or the counting finished and the state of reset (off).

The counting in action is considered when the first pulse is acquired after the reset.

After the reset, the display visualizes 0000 if the counting mode is programmed as UP (par. "C" = 1) or it visualizes the programmed set value if the counting mode is programmed as DOWN (par. "C" = 2).

The par. "d" permits the user to divide the number of pulses received by the input and to use the result as the counting value of the counter (both for display and the outputs operating mode).

4.3 - OUT1 OPERATING MODE

The instrument can be programmed by the parameter "F1" to operate in any of the following 3 modes:

F1 = 1 - RESTART:

When reaching the programmed set or the 0000 value (depending on whether the counting mode is UP or DOWN) the output OUT1 is activated and it remains in this state for the whole time programmed in the "r" parameter; the display shows the value reached, and the counter does not count any pulses received during this time.

When the "r" time has elapsed the output is deactivated and the counter automatically resets counting, thus setting itself for a new cycle: it then starts again to count the pulses received.

Therefore, reset of counting and output occurs when the "r" time has elapsed.

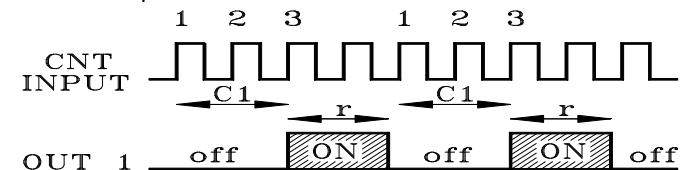

F1 = 2 - RESTART-LAP:

This operating mode is similar to the previous one, the only difference being that during the "r" time the counter - even though it continues to display the value reached and maintains the output activated - counts all the eventual pulses it receives. When the "r" time has elapsed, output is deactivated and counting continues starting from the value reached during the "r" time.

Therefore, the counting reset occurs when the programmed set has been reached, while the output OUT1 reset is carried out when the "r" time has elapsed.

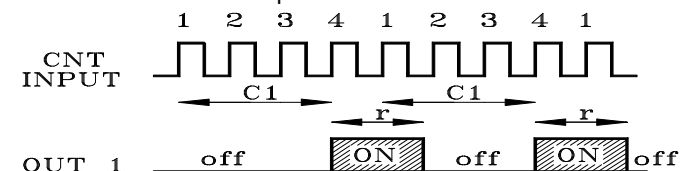

F1 = 3 - COUNT:

The output OUT1 is activated when the programmed set or the 0000 value have been reached (counting mode may be UP or DOWN), and it remains activated until receiving the manual reset control, which can be transmitted by the remote input RES or the front key.

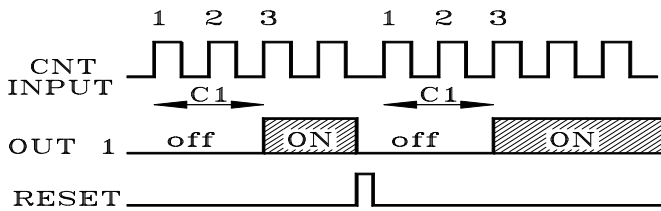

4.4 - OUT2 OPERATING MODE

The instrument can be programmed by the parameter "F2" to operate on OUT2 in any of the following 4 modes:

F2 = 1 - Output OUT2 operating like OUT1

The output OUT2 exactly operates like the output OUT1 so that to be able to have two output contacts.

F2 = 2 - Output OUT2 operating as counting in progress

The output OUT2 is activated when the first pulse is acquired and remains activated to the reset command.

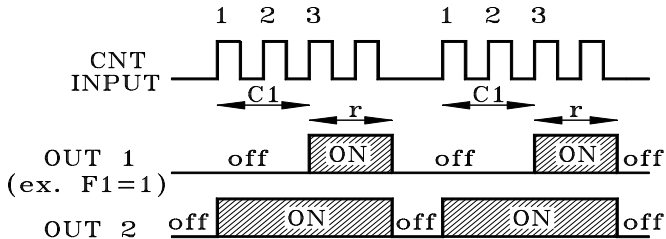

F2 = 3 - Same function of OUT1 with set C2 absolute:

The choice of this mode of operation enable the set "C2" that cannot be higher of "C1".

The instrument operating on the output OUT 2 in the same way with which it operates the function F1 on the output OUT1 but with set "C2".

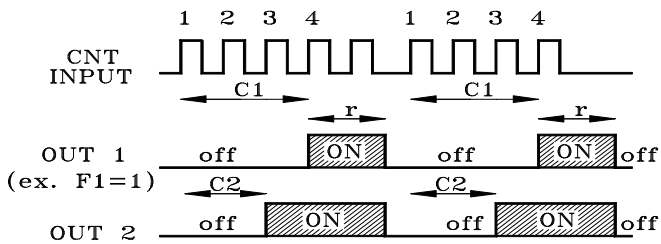

F2 = 4 - Same function of OUT1 with set C2 relative to set C1 (in advance):

The choice of this mode of operation enable the set "C2" that cannot be higher of "C1".

The instrument operating on the output OUT 2 in the same way with which it operates the function F1 on the output OUT1 but with set ["C1" - "C2"].

In the programming mode of the set "C2" the display shows "C2 d" to indicate that the set C2 is dependent.

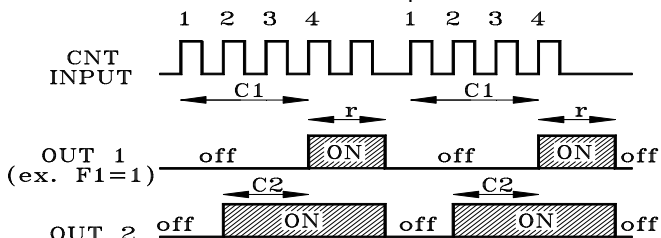

If "F2" = 0 the output OUT 2 is always disabled.

5 - PROGRAMMABLE PARAMETERS

5.1 - PARAMETERS TABLE

Par.	Description	Range	Def.	
1	F1	OUT 1 operating mode	1 - 2 - 3	1
2	F2	OUT 2 operating mode	0 - 1 - 2 - 3 - 4	0
3	H1	Maximum set	0000 .. 9999	9999

4	C	Counting mode	1 - 2	1
5	r	Restart time	1 ... 250 décimas de seg.	1
6	H	Maximum frequency of input	1 - 2 - 3 - 4 - 5	2
7	d	Counting division	1 ... 9999	1
8	b	Back-up mode	1 - 2	1
9	E	RES input operating mode	1 - 2	1
10	t	key operating mode	0 - 1	1

5.2 - PARAMETERS DESCRIPTION

F 1 - OUT 1 OPERATING MODE: Permits the user to select the operating mode of the output OUT 1 as regards counting.

The 3 mode are:

- 1 = RESTART
- 2 = RESTART-LAP
- 3 = COUNT

F 2 - OUT 2 OPERATING MODE: Permits the user to select the operating mode of the output OUT 2 as regards counting.

The 5 mode are:

- 0 = Output disable
- 1 = Operating like OUT1
- 2 = On during counting
- 3 = Same function of OUT1 with set C2 absolute
- 4 = Same function of OUT1 with set C2 dependent from set C1

H1 - HIGH SET POINT C1 : This parameter allows the user to program the Higher value programmable as Set Point "C1"

C - COUNTING MODE: It establishes whether counting must be carried out by increments (UP) or decrements (DOWN), i.e. whether the display must show the pulses which have been counted or remaining pulses. The options are:

- 1 = UP
- 2 = DOWN

r - RESTART AND RESTART-LAP TIME: This parameter allows the user to determine the automatic reset delay time in "F1"= 1 and "F1"= 2 operating modes (refer to what has already been said in the description of these operating modes). Programming options for this parameter are: 1 ... 250 (tenths of sec.)

H - MAXIMUM COUNTING FREQUENCY: This parameter acts on a software filter and allows the user to select the maximum acceptable input frequency for counting, and it is used according to the type of signal transmitted at the input port (from relay, contact, encoder, etc.). The options are:

- 1 = 2 Hz
- 2 = 10 Hz
- 3 = 40 Hz
- 4 = 125 Hz
- 5 = 1000 Hz

d - COUNTING DIVISION: This parameter permits the user to divide the number of pulses received by the counting input and to use the result as the counting value of the counter (both for display and the output operating mode). Programming options for this parameter are: 1 ... 9999

b - BACK-UP MODE : It determines counter behaviour in case of power failure. The options are:

- 1 = It stores counting: in the eventuality of power failure the counter stores the value reached, and when the power supply is restored it restarts counting from this value.
- 2 = It resets counting: in the eventuality of power failure the counter does not store the value reached, and when the power supply is restored it restarts counting from 0000 (if in UP mode) or the set value (if in DOWN mode).

E - RES INPUT OPERATING MODE. Allows the user to select the operating mode of the RES external input. The options are:

- 1 = RESET
- 2 = REVERSE COUNTING

t - U KEY OPERATING MODE: This parameter permits to decide the operating mode of the frontal U key and the possibilities are:

- 0 = Key disable
- 1 = RESET

6- PROBLEMS, MAINTENANCE AND WARRANTY

6.1 – CLEANING

It's recommended to clean the instrument only with a cloth wetted with water or with a detergent neither abrasive nor containing solvents.

6.2 – WARRANTY AND REPAIRS

The instrument is under warranty against construction vices or defected material, noticed within 12 months from delivery date. The warranty is limited to the repairs or to the substitution of the instrument. The eventual opening of the housing, the violation of the instrument or the wrong use and installation of the product means the automatic decay of the warranty.

In case of defected instrument, noticed in warranty period or out of warranty, do contact our sales department to obtain the shipment authorisation.

The defected product must be shipped to OSAKA with the detailed description of the failures found and without any fees or charge for OSAKA, safe different agreements.

7 - TECHNICAL DATA

7.1 – ELECTRICAL DATA

Power supply: 12 VDC/VAC, 24, 115, 230 VAC +/- 10%

Frequency AC: 50/60 Hz

Power consumption: 3 VA approx.

Input/s: 2 digital inputs for Count (CNT) and Reset (RES) for voltage-free contacts or voltage signals (the same voltage supply value).

Output/s: Up to 2 outputs. Relay SPDT (8 A-AC1, 3 A-AC3 / 250 VAC); or in tension to drive SSR (12VDC/15 mA).

Electrical life for relay outputs: 100000 operat.

Voltage inputs absorption: 1 mA Max.

Installation category: II

Protection class against electric shock: Class II for Front panel

Insulation: Reinforced insulation between the low voltage section (supply and relay outputs) and the front panel; Reinforced insulation between the low voltage section (supply and relay outputs) and the extra low voltage section (inputs, SSR outputs); Reinforced insulation between the extra low voltage section (SSR outputs) and voltage inputs.

7.2 – MECHANICAL DATA

Housing: Self-extinguishing plastic, UL 94 V0

Dimensions: 48 x 48 mm DIN, depth 98 mm

Weight: 200 g approx.

Mounting: Flush in panel in 45 x 45 mm hole

Connections: 2 x 1 mm 2 screw terminals block

Degree of front panel protection : IP 54 mounted in panel with gasket

Pollution situation: 2

Operating temperature: 0 ... 50 °C

Operating humidity: 30 ... 95 RH% without condensation

Storage temperature: -10 ... +60 °C

7.3 – MECHANICAL DIMENSIONS, PANEL CUT OUT AND FIXING DEVICE [mm]

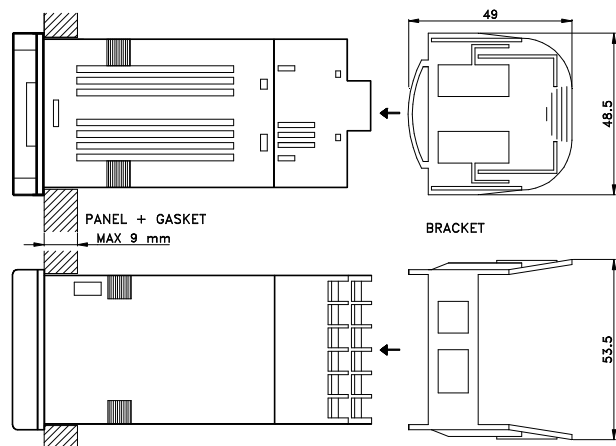
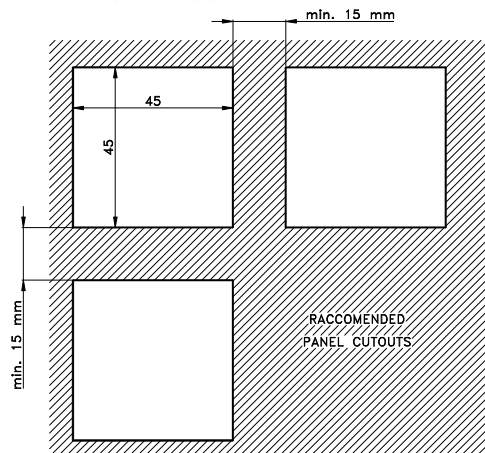
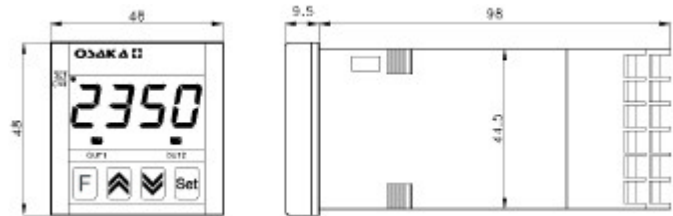

7.4 – FUNCTIONAL DATA

Outputs operating mode: 3 modes for OUT 1: RESTART, RESTART-LAP, COUNT. 4 modes for OUT 2: like OUT1, ON during count, like OUT1 with set C2 absolute or relative in advance.

Measurement range: 9999 Max.

Max counting input frequency: programmable from 2Hz up 1000 Hz

RES Input delay: 15 m sec. Max.

Display: 4 Digit Red h 12 mm

Compliance: ECC directive EMC 89/336 (EN 61326), ECC directive LV 73/23 and 93/68 (EN 61010-1)

7.5 – INSTRUMENT CODE

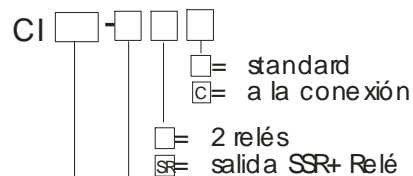

- A= 230 Vac
- B= 110 Vac
- E= 24 Vac
- D= 12 Vac/dc

- 49 = formato (48x48), Ip65
- 73 = formato (72x72), Ip65